



Merrychef **eikon**[®] **e1s** high speed oven

GB

**Microwave combination oven
Operations and installation guide CE**

Part number: 32Z3972



Read instructions before use

Expanding your opportunities[™]

www.merrychef.com

Table of contents

| | |
|--|-----------|
| Document information | 5 |
| EC Declaration of Conformity..... | 6 |
| Environmental protection | 7 |
| Statement of principles..... | 7 |
| Environmental protection procedures..... | 7 |
| Correct disposal of this product (waste electrical & electronic equipment)..... | 7 |
| Noise emission..... | 7 |
| 1A. Summary of design, operational hazards and safety devices | 9 |
| Warning and safety signs..... | 9 |
| Parts and safety devices..... | 10 |
| Hazard points | 11 |
| 1B. General safety | 12 |
| General cautions..... | 12 |
| Restrictions on use | 12 |
| Precautions when using the appliance | 13 |
| Instructions for safe use of the appliance | 13 |
| Requirements to be met by operating personnel | 14 |
| Operating condition requirements..... | 14 |
| Operating environment requirements..... | 15 |
| Cleaning safely requirements..... | 16 |
| Emergency instructions..... | 16 |
| 1C. Requirements to be met by operating personnel working positions..... | 17 |
| 1D. Hazards and safety precautions during installation and setting up | 18 |
| Personal protective equipment requirement | 18 |
| Safety precautions relating to the installation location | 18 |
| Potential risks during installation and setting up | 19 |
| 1E. Hazards and safety precautions when preparing appliance for use | 20 |
| Personal protective equipment requirement | 20 |
| Safety precautions for preparation for first use | 20 |
| 1F. Hazards and safety precautions during operation..... | 21 |
| Personal protective equipment requirement | 21 |
| General rules..... | 21 |
| Restrictions on use | 21 |
| Instructions for safe use of the appliance | 21 |
| Potential risks during operation | 22 |
| 1G. Hazards and safety precautions during cleaning | 23 |
| Personal protective equipment requirement | 23 |
| General cleaning safety rules and requirements..... | 23 |
| Potential risks during cleaning..... | 23 |
| 1H. Hazards and safety precautions during servicing and repair | 24 |
| Personal Protective Equipment..... | 24 |
| Potential risks to move appliance..... | 24 |



| | | |
|------------|--|-----------|
| | Rules for moving and setting up the wheeled trolley safely..... | 25 |
| | Risk of burns..... | 25 |
| 1I. | Hazards and safety precautions when taking the appliance out of service | 26 |
| | Personal protective equipment | 26 |
| | General precautions..... | 26 |
| | Potential risks..... | 26 |
| 2A. | Introduction to e1s..... | 28 |
| | Identifying your microwave combination oven..... | 28 |
| | Appliance parts and their functions | 29 |
| | Equipment and accessories supplied..... | 30 |
| 2B. | Installing the appliance | 31 |
| | Unpacking..... | 31 |
| | Taking the appliance off the pallet | 31 |
| | Installation location requirements | 32 |
| | Electrical installation requirements..... | 33 |
| 2C. | Getting started..... | 35 |
| | Fitting the air filter | 35 |
| | Inserting the cook plate | 35 |
| | Turning the oven on and off..... | 35 |
| | Settings on first usage..... | 36 |
| | Selecting suitable utensils..... | 37 |
| | Preheating the oven | 37 |
| | Understanding the main menu and keyboard..... | 38 |
| 2D. | Cooking procedures..... | 39 |
| | How to cook..... | 39 |
| | Using a cooking profile – quick serve mode | 40 |
| | Using a cooking profile – full serve mode..... | 41 |
| | Choosing cooking profiles for Press&Go menu | 42 |
| | Changing the cavity temperature | 43 |
| 2E. | Cooking profiles | 44 |
| | Creating a cooking profile..... | 44 |
| | Viewing and editing cooking profiles..... | 45 |
| | Moving a cooking profile in a group of cooking profiles..... | 45 |
| | Moving a cooking profile in a list | 46 |
| | Adding a new cooking profile group..... | 46 |
| | Adding a cooking profile to a group of cooking profiles | 47 |
| | Deleting a cooking profile group..... | 47 |
| | Editing a selected cooking profile group name..... | 48 |
| 2F. | Changing settings | 49 |
| | Changing settings process..... | 49 |
| | Operating mode / navigation settings..... | 50 |
| | Language settings..... | 50 |
| | Cavity temperature settings and labels | 51 |
| | Service information and error logs..... | 52 |
| | Cooking profile counters..... | 52 |



| | |
|---|-----------|
| Setting the date and time | 53 |
| Sound settings..... | 54 |
| Temperature timer setting | 55 |
| USB programme downloads | 56 |
| Temperature band setting..... | 57 |
| Change setting / service access password..... | 57 |
| Set screen saver | 58 |
| 2G. Cool-down procedures | 59 |
| 2H. Cleaning procedures..... | 60 |
| Daily cleaning tasks | 60 |
| Cleaning instructions..... | 61 |
| 2I. End of day operations | 64 |
| Turning the oven off..... | 64 |
| 2J. Servicing information | 65 |
| Warranty information and contacting customer services | 65 |
| Fault finding..... | 66 |



Document information

Version control

| Date | Issue number | Description | Issued by |
|-------------------------------|--------------|--|-----------|
| 24 th January 2020 | 08 | Installation and operating instructions and procedures for eikon e1s | Merrychef |

Document purpose

The purpose of this guide is to give a brief introduction to the Merrychef eikon e1s oven. It is intended to get you started as well as to provide instructions on how to operate the system on a regular basis.

Related documents

This document forms part of the overall Merrychef eikon e1s user manual set, which contains two guides:



- Operations and Installation Guide
- Service and Repair Guide

How to use this guide

This guide should be read prior to installing and using the appliance. It should also be used in conjunction with the Service and Repair Guide.

Symbols and their meanings

Important information has been highlighted throughout this section using symbols and warning notices.

| Symbol | Meaning |
|---|--|
|  | Warnings of potential injuries. Heed all the warning notices that appear after this symbol to avoid potential injuries or death. |
|  | See specified section or guide. |
|  | Take note of this information. |

Warning notices

| Hazard level | Consequences | Likelihood |
|--|---------------------------------------|----------------|
|  DANGER | Death / serious injury (irreversible) | Immediate risk |
|  WARNING | Death / serious injury (irreversible) | Potential risk |
|  CAUTION | Minor injury (reversible) | Potential risk |
|  DAMAGE | Damage to property | Potential risk |



EC Declaration of Conformity

Manufacturer

Authorised Representative (Brand Headquarters)

Welbilt UK Limited
Ashbourne House, The Guildway,
Old Portsmouth Road
Guildford GU3 1LR
United Kingdom

Factory

Welbilt (Foshan) Foodservice Co., Ltd.
Chuang Ye Road, Song Gang Song Xia Industrial Park,
Nanhai District, Foshan Guangdong,
China 528234

Validity of Conformity

This declaration of conformity applies to the following electrical appliance models:

Commercial microwave combination oven; eikon e1s.

Compliance of Electrical Appliances with Directives

The manufacturer declares that the commercial microwave combination oven specified above complies with the following European Directives:

- 2006/42/EC (Machinery Directive),
- 2014/30/EU (EMC Directive),
- 2011/65/EU (RoHS Directive)

The safety objectives of European Directive 2014/35/EU (Low Voltage Directive) have been met in accordance with Annex I, Section 1.5.1 of the Machinery Directive.

Compliance of Electrical Appliances with Standards

The electrical appliances comply with the requirements in the following European standards

- EN 60335-1: 2012+ A11:2014
- EN 60335-2-90: 2006 + A1: 2010 (excl. Annex EE Ship board requirements)
- EN 55011: 2016 A1: 2017
- EN 55014-2:1997+Corri+A1:2001+A2:2008 in accordance with Category IV requirements
- EN 61000-3-2: 2014
- EN 61000-3-11: 2013
- EN 61000-6-2: 2005
- EN 62233: 2008
- EN50581: 2012
- EN1672-2: 2005+A1: 2009

Authorised Representative

Authorised to compile the technical documentation is in accordance with Annex II A Section 2 of Directive 2006/42/EC Welbilt UK Limited, Ashbourne House, The Guildway, Old Portsmouth Road, Guildford GU3 1LR, United Kingdom.

Place and Date of issue: Guildford, 14th March 2018.



Mr Philip Radford

Vice President Products: Merrychef (on behalf of the Authorised Representative)

Environmental protection

Welbilt UK employs a quality management system in accordance with EN ISO 9001:2008 and a certified environmental management system in accordance with EN ISO 14001.

Statement of principles

Our customers' expectations, the legal regulations and standards and our company's own reputation set the quality and service for all our products.

We have an environmental management policy that not only ensures compliance with all environmental regulations and laws, but also commits us to continuous improvement of our green credentials.

We have developed a quality and environmental management system to guarantee the continued manufacture of high-quality products and to be sure of meeting our environmental targets.

This system satisfies the requirements of ISO 9001:2008 and ISO 14001:2004.

Environmental protection procedures

We observe the following procedures:

- Use of RoHS2-compliant products
- REACH chemical law
- Recycling of electronic waste
- Environmentally friendly disposal of old appliances via the manufacturer

Correct disposal of this product (waste electrical & electronic equipment)



Applicable in the European Union and other European countries with separate collection systems. This marking shown on the product or its literature indicates that it should not be disposed with other household wastes at the end of its working life. To prevent possible harm to the environment or human health from uncontrolled waste disposal, please separate this from other types of wastes and recycle it responsibly to promote the sustainable reuse of material resources.

Household users should contact either the retailer where they purchased this product, or their local government office for details of where and how they can take this item for environmentally safe recycling.

Business users should contact their supplier and check the terms and conditions of the purchase contract.

This product should not be mixed with other commercial wastes for disposal.

Noise emission

The weighted emission sound pressure is <70 dBA.



Section 1: Safety

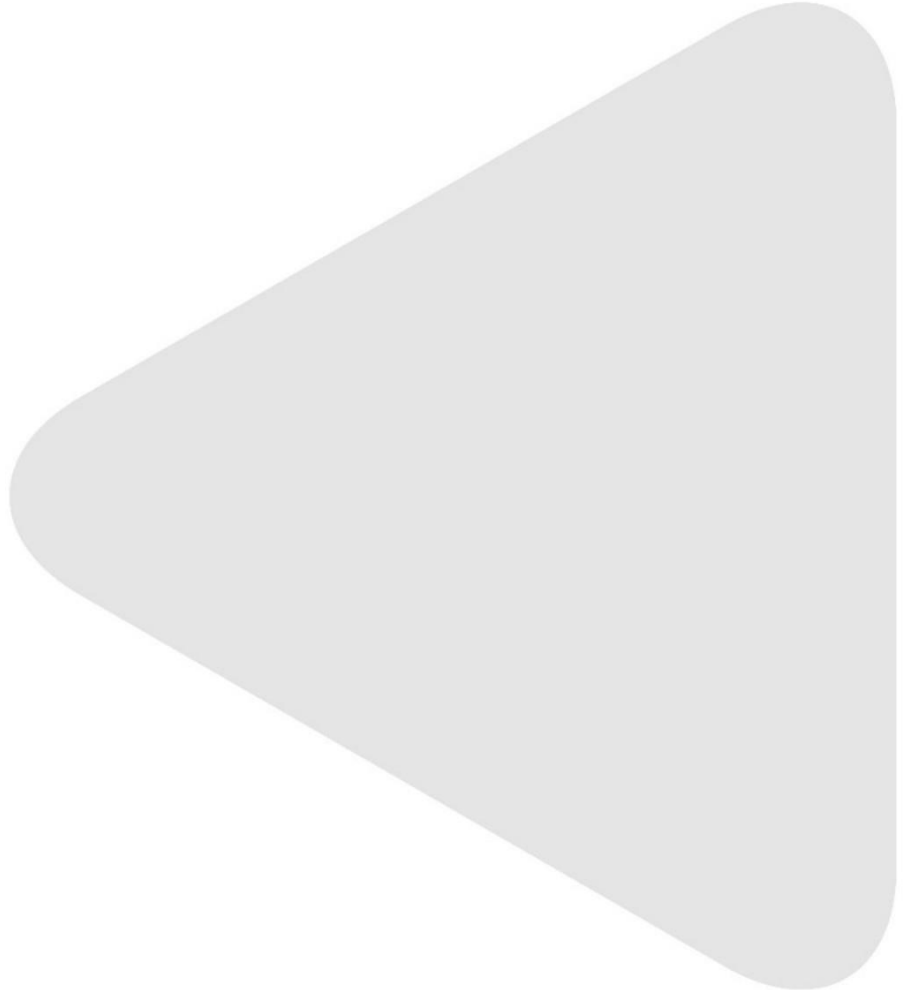

1A. Summary of design, operational hazards and safety devices

The information in this section should be read and understood by Facility Managers, Chefs, Users and Service Technicians.

The microwave combination oven is designed to protect the user from all hazards that can reasonably be avoided by design measures. The actual purpose of the microwave combination oven, however, means that there are still residual risks; you must therefore take precautions to avoid them. A safety device can provide you with a certain degree of protection against some of these hazards. You must ensure, however, that these safety devices are in place and in working order.

Warning and safety signs

The following warning signs/notices must be attached to the microwave combination oven and optional accessories in the area indicated so as to be easily visible at all times.



| Area | Symbol | Descriptions |
|------|--------|--|
| 1 | | Microwaves warning There is a risk of external and internal burns of body parts following exposure to microwave energy. |
| 2 | | Electric shock warning There is a risk of electric shock if the appliance is serviced without disconnecting the electrical supply. |
| 3 | | Fire / electric shock warning There is a risk of fire / electric shock if the appliance is operated without respecting the minimum clearances. |
| 4 | | Hot surface warning There is a risk of burns from high temperatures inside the cavity and on the inside of the appliance door. |
| 5 | | Electric shock warning There is a risk of electric shock if the electrical power is not connected to a properly grounded outlet. |
| 6 | | Equipotential bonding |

Table 1.1: Meaning of signs

Figure 1.1: Warning and safety signs on appliance



Parts and safety devices

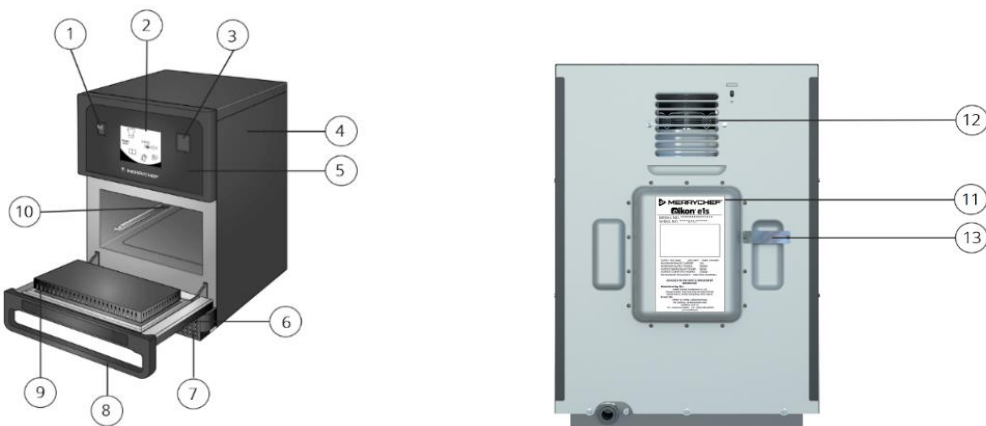

Figure 1.2: e1s front and rear views – parts and safety devices

| Item | Part / safety device | Function and precautions |
|------|---------------------------------|--|
| 1 | ON/OFF appliance switch | Used to turn the microwave combination oven on and off. However, turning this switch off does not isolate the appliance from the electricity supply. |
| 2 | easyToUCH® screen control panel | The easyToUCH® screen illuminates to alert the user that the appliance is switched on. |
| 3 | USB port | A USB socket located under the cover allows updates to programmes stored on the appliance. |
| 4 | Protective cover | The cover can only be removed with specific tools. It prevents live parts from being touched accidentally and prevents access to the moving fan. Always ensure the cover is securely in place. |
| 5 | Operating panel | Can only be removed using specific tools and prevents live parts from being touched accidentally. Always ensure the panel is in place. |
| 6 | Appliance door | Protects the user and outside environment from hot steam and microwave energy. Check the door regularly for damage and replace it if required. |
| 7 | Air filter | The air filter is part of the ventilation system and should be free of obstruction and cleaned daily. |
| 8 | Door handle | The door handle is a rigid bar which is pulled downwards and away from the appliance to open it. |
| 9 | Door seals | The tight seals around the door ensure protection from microwave energy leaking from the cavity. Check the door seals regularly for signs of damage and replace it if required. |
| 10 | Cavity | The cavity (cooking chamber) is constructed from stainless steel and used for cooking products. Keep it clean by following the appliance's cleaning procedures. |
| 11 | Nameplate | A label that is attached at the rear of the oven and states the serial number, model type and electrical specifications. |
| 12 | Air outlets | To allow air used to cool internal components and steam from the cavity to escape. The air outlets must be kept free from obstruction and they will not allow microwave energy to escape into the environment. |
| 13 | Steam pipe and cover | A covered pipe from the cavity to the back of the oven to vent steam during cooking and prevent pressure build up. |

Table 1.2: Parts – functions and precautions



Other safety devices

| Safety device | Functions | Checks / Actions |
|---|---|--|
| Door interlocks - Electric door sensor for appliance door | <ul style="list-style-type: none"> Ensures that the microwave generation system cannot be powered when the door is open | <p>Check door switch:</p> <ul style="list-style-type: none"> Action: Open the appliance door fully and press Start Result: Door open warning message |
| Disconnection device | <ul style="list-style-type: none"> Installed by the customer close to the appliance; easily visible and accessible, 1- or 3-pole action, minimum contact separation 3mm Used to disconnect the appliance from the power supply during cleaning, repair and servicing work and in case of danger | <p>Action:</p> <ul style="list-style-type: none"> Trip the disconnection device Unplug appliance such that from any access point the operator can check the plug remains removed Use of disconnection with a locking system in the isolated position |
| Internal fuses | <ul style="list-style-type: none"> Prevent faulty components from drawing too much current and causing potential fire hazard | <ul style="list-style-type: none"> Ensure that the internal fuses are correctly rated |

Table 1.3: Safety devices - actions and checks

Hazard points

Heat generation (1)

The microwave combination oven becomes hot inside the cavity and on the inside of the appliance door. This poses a risk of burns on hot surfaces inside the microwave combination oven, and also on hot appliance parts, food containers and other accessories used for cooking.

Hot steam / vapour (2)

When cooking food, the microwave combination oven may generate hot steam and vapour which escapes when the appliance door is opened and which is removed through the air vents on the rear of the microwave combination oven when the appliance door is closed. This poses a risk of scalding from hot steam when the appliance door is opened. Take particular care when opening the appliance door if the top door edge is below your field of vision.

Live components (3)

The microwave combination oven contains live parts. This means a risk from live parts if the cover is not in place.

Parts moving against each other (4)

For various actions, such as opening/shutting the appliance door or cleaning the appliance door, there is the risk that you will crush or cut your hand.

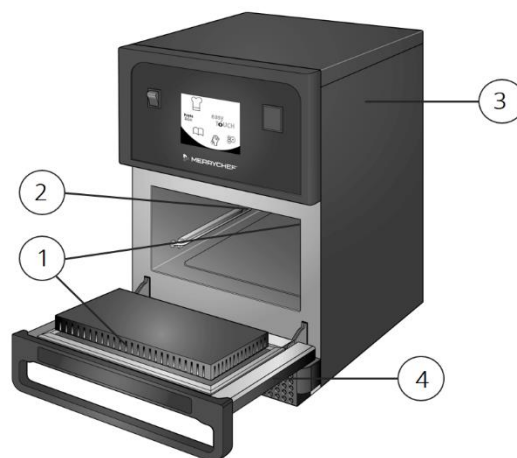

Figure 1.3: Hazard points



1B. General safety

The information in this section should be read and understood by Facility Managers, Chefs, Users and Service Technicians.

IMPORTANT SAFETY INSTRUCTIONS

When using electrical appliances, basic safety precautions should be followed as detailed in this section.

General cautions

To reduce the risk of burns, electric shock, fire, injury to persons, or exposure to excessive microwave energy:

- The microwave combination oven should only ever be used for the specified purposes.
- Read all instructions before using the appliance.
- Installation of the microwave combination oven must comply with all national and regional laws and regulations as well as the local regulations of the relevant utility companies and local authorities along with any other related requirements.
- Children shall not use or play with the appliance.
- Changes should not be made to the microwave combination oven, e.g. removing parts or fitting unapproved parts. In particular, the safety devices should never be disabled.
- Always keep at hand the *Operations and Installation Guide* for reference and pass it to the new user if the oven changes ownership.

Restrictions on use

- Do not use corrosive chemicals or vapours in this appliance. This type of oven is specifically designed to heat, cook or toast food. It is not designed for industrial or laboratory use.
- No highly flammable objects with a flash point below 270°C / 518°F, such as highly flammable oils, fats or cloths (kitchen cloths).
- Never use the appliance to heat alcohol, e.g. brandy, rum, etc. Food containing alcohol can more easily catch fire if overheated. Observe caution and do not leave the appliance unattended.
- Never attempt to deep fry in the oven.
- Do not heat dry powder or granulated material.



- Eggs in their shell and hard-boiled eggs should not be heated in microwave ovens since they may explode even after microwave heating has ended.
- Do not operate the appliance using microwave only or combination function without food or liquid inside the cooking chamber, as this may result in overheating and cause damage.
- Do not use the appliance to dry linen.
- Do not attempt to operate the appliance with:
 - An object caught in the door
 - A door that does not close properly
 - A damaged door, hinge, latch or sealing surface
 - Without food in the oven

⚠ WARNING

- Liquids or other foods must not be heated in sealed containers or jars since they are liable to explode.

Precautions when using the appliance

⚠ WARNING

- Microwave heating of beverages can result in delayed eruptive boiling. Therefore, care must be taken when handling the container.
- When handling hot liquids, foods and containers, care should be taken to avoid scalds and burns.
- As with any cooking appliance, care should be taken to avoid combustion of the items within the appliance.

Instructions for safe use of the appliance

- Only use utensils that are suitable for use in microwave combination ovens.
- Foods must not be heated in completely sealed containers as the build-up of steam may cause them to explode
- Extra precautions must be taken when heating and handling liquid:

⚠ CAUTION

- When heating liquids using microwave only or combination function, the contents should be stirred prior to heating to help prevent eruptive boiling.
- Only use containers of appropriate size.
- Insert the food containers correctly.



- Always place containers holding liquids or holding food that will liquefy during cooking on shelves that allow a proper view into the container for all users.
- Always take out horizontally any containers holding liquids or holding food that will liquefy during cooking.
- **⚠ WARNING** The contents of feeding bottles and baby food jars must be stirred or shaken and the temperature checked before consumption to avoid burns.
- Items should be unwrapped when using convection and combination functions.
- Excess fat should be removed during 'roasting' and before lifting heavy containers from the oven.
- Food with a skin, e.g. potatoes, apples and sausages should be pierced before heating.
- When heating food in plastic or paper containers, keep an eye on the oven due to the possibility of ignition.
- Food in combustible plastic or paper containers should be transferred to a microwave-proof/ovenproof container.
- In the event of glass breaking or shattering within the oven, ensure that food is totally free of glass particles. If in doubt, dispose of any food that was in the oven at the time of the breakage.
- Switch off the appliance at the end of all the cooking sessions for that day.

Requirements to be met by operating personnel

⚠ WARNING

- This appliance is not intended for use by persons (including children) with reduced physical sensory or mental capabilities or lack of experience and knowledge unless they have been given supervision or instruction concerning use of the appliance in a safe way and understand the hazards involved. Children shall not play with the appliance. Cleaning and user maintenance shall not be made by children.
- It is hazardous for anyone other than a competent person to carry out any service or repair operation that involves the removal of any cover which gives protection against exposure to microwave energy. See *1E: Requirements to be met by operating personnel*.

Operating condition requirements

- As with all electrical appliances, it is recommended to have the electrical connections inspected at least once a year.



- This appliance must be grounded. Connect only to a properly grounded outlet. See *Section 2B*.
- **⚠DANGER** If the supply cord is damaged, it must be replaced by the manufacturer, its service agent or similarly qualified persons in order to avoid a hazard.
- **⚠DANGER** The appliance must be disconnected from its power supply during maintenance and when replacing parts.
 - Unplug appliance such that from any access point the operator can check the plug remains removed.
 - Use of disconnection with a locking system in the isolated position is recommended in order to avoid a hazard.
- Never remove the external covers of the appliance.
- Never remove any fixed internal parts of the appliance.
- Never tamper with the control panel, door, seals, or any other part of the appliance.
- Never hang dish towels or cloths on any part of the appliance.
- The appliance must not be operated without the air filter in place.
- **⚠WARNING** If the door or door seals are damaged, the oven must not be operated until it has been repaired by a competent person. See *Section 1C. Requirements to be met by operating personnel*.

Operating environment requirements

- This appliance is not intended for mobile use, such as in marine or vehicle applications.
- The appliance must not be installed or operated outdoors.
- Ensure dry floor. The floor adjacent to the appliance may be slippery. Clean up spillages immediately.

⚠DAMAGE

- The minimum height of free space necessary above the top surface of the appliance is 50mm (2").
- The minimum depth requirement is as follows:
 - Width of appliance = 406.4mm (16")
 - Total depth with door open = 806.9mm (31.8")
 - Counter depth = 499.0mm (19.6")
- Safety clearance requirement on the left and right of the oven is 0mm.



Cleaning safely requirements

- Personnel charged with cleaning must be trained regularly by the person responsible for the microwave combination oven.
- The oven should be cleaned regularly and any food deposits removed.
- The oven must already be cool or cooled down following the correct procedures specified in *Section 2G*.
- Use only cleaning chemicals that have been approved by the manufacturer.
- High-pressure cleaners or water jets must not be used for cleaning.
- The appliance must not be treated with alkali or acid solutions or exposed to acid fumes.
- The cooking chamber of the appliance and the door seals should be cleaned frequently. Failure to maintain the appliance in a clean condition could lead to deterioration of the surface, which could adversely affect the life of the appliance and possibly result in a hazardous situation. Details for cleaning door seals, cavities and adjacent parts are provided in *Section 2H*.
- Ensure that the cavity has been cleaned thoroughly of any cleaning agents with warm water, then wipe with a soft cloth or paper towel.
- The air filter (Figure 1.2, item 7) is part of the ventilation system and should be cleaned daily.
- Do not heat up the appliance if there are cleaning chemicals inside.



Full cleaning procedures are detailed in Section 2H.

Emergency instructions

⚠ DANGER

- If smoke is observed, switch off the appliance. Unplug or isolate it from the electrical supply and keep the door closed in order to stifle any flames.

SAVE THESE INSTRUCTIONS



1C. Requirements to be met by operating personnel working positions

The information in this section should be read and understood by Facility Managers, Chefs, Users and Service Technicians.

| Personnel | Qualifications | Tasks |
|---------------------------|--|--|
| Facility Manager | <ul style="list-style-type: none"> • Has relevant professional training • Trained in how to operate the microwave combination oven | <p>Responsible for staff safety. To guarantee safety:</p> <ul style="list-style-type: none"> • Only personnel who demonstrably understand the hazards detailed in this section and strictly follow the precautions and proper usage of instructions provided should be permitted to use the microwave combination oven • Ensure ALL personnel coming in to contact with the microwave combination oven use the Personal Protective Equipment for each task as detailed at the start of each section of this safety guide |
| Chef | <ul style="list-style-type: none"> • Has relevant professional training • Knows relevant national food legislation and regulations, plus hygiene legislation and regulations • Must keep records in accordance with Hazard Analysis and Critical Control Points (HACCP) • Trained in how to operate the microwave combination oven | <p>Essentially performs organisational tasks such as:</p> <ul style="list-style-type: none"> • Entering the cooking profile data • Editing existing cooking profiles in the cookbook • Developing new cooking profiles • Adjusting appliance settings • They may also perform all user tasks if applicable |
| User | <ul style="list-style-type: none"> • Semi-skilled • Trained in how to operate the microwave combination oven • Works under supervision • Knows the regulations associated with handling heavy loads | <p>Essentially performs specific operating tasks such as:</p> <ul style="list-style-type: none"> • Loading the microwave combination oven • Starting a cooking profile • Removing food • Cleaning the microwave combination oven. • Fitting accessories in the microwave combination oven • Minor servicing tasks |
| Equipment mover | <ul style="list-style-type: none"> • Trained in the use of a pallet truck and forklift truck • Knows the regulations associated with handling heavy loads | <ul style="list-style-type: none"> • Conveying within the establishment |
| Service technician | <ul style="list-style-type: none"> • Is an authorised service agent • Has relevant technical training • Is trained in the particular appliance • Knows the regulations associated with handling heavy loads | <ul style="list-style-type: none"> • Setting up the appliance • Preparing the appliance for first-time use and taking the appliance out of service • Instructing the user |

Table 1.4: Personnel – qualifications and tasks



1D. Hazards and safety precautions during installation and setting up

The information in this section should be read and understood by Facility Managers, Equipment Movers and Service Technicians.

Personal protective equipment requirement

When installing or moving the appliance, ensure the following personal protective equipment is used:

- Protective gloves
- Safety boots
- Hard hat (e.g. when heavy loads are being lifted and working overhead)

To ensure local and national standards and regulations relating to workplaces in catering kitchens and the installation location are observed, only Service Technicians are permitted to set up the appliance.

Safety precautions relating to the installation location

To prevent hazards that arise from the installation site and environment of the appliances, the following rules must be observed:

- The floor adjacent to the appliance may be slippery. Clean up spillages immediately.
- The location for installation must comply with operating conditions requirements:
 - The ambient temperature lies between +4°C /40°F and +35°C/95°F
 - Not a toxic or potentially explosive atmosphere
 - Dry kitchen floor to reduce the risk of accidents
-  **DAMAGE** Minimum space requirement must be complied with:
 - The minimum height of free space necessary above the top surface of the appliance is 50mm (2").
 - The minimum depth requirement is as follows:
 - Width of appliance = 406.4mm (16")
 - Total depth with door open = 806.9mm (31.8")
 - Counter depth = 499.0mm (19.6")
 - Safety clearance on left-/right-hand side / at rear: 0mm
- The appliance must not be installed directly under a fire alarm or sprinkler system. Fire alarm installations and sprinkler systems must be set up to handle the level of steam and vapour expected to escape from the appliance when the door is opened.
- There is a risk of fire from the heat emitted from hot surfaces. Therefore, flammable materials, gases or liquids must not be located near, on or below the appliance.
- It must be possible to set up the microwave combination oven in the installation position so that it cannot tip over or slide about. The supporting surface must comply with these requirements.
- Vibrations must generally be avoided when using wheeled oven stands or wheeled stacking kits.
- Heat sources in the vicinity must lie at a minimum distance of 500mm (20").
- The appliance must be installed so that there is absolutely no possibility that liquid from the appliance or liquid coming from cooking processes can reach deep-fat fryers or appliances that use hot, uncovered fat. Deep-fat fryers or appliances that use hot, uncovered fat, and which are located in the vicinity must lie at a minimum distance of 500mm / 20in.



- Requirements for supporting surface is met.
 - The supporting surface must be flat and level.
 - The supporting surface must have a non-slip surface.
 - The supporting surface must be able to bear the in-use weight of the appliance, plus the weight of the structure supporting the appliance as follows: 50Hz = 46kg /101lbs and 60Hz = 45kg / 99lbs.

Potential risks during installation and setting up

Risk of injury from lifting heavy weights incorrectly

⚠ WARNING

When lifting the appliance, the weight of the appliance may lead to injuries, especially in the torso area. To avoid this:

- Use a fork-lift truck/pallet truck to move the appliance.
- Use suitable lifting gear.
- When lifting the appliance, use enough people for the weight of the appliance (value depending on age and gender). Observe the local occupational safety regulations for lifting and carrying.

Risk of body parts being crushed when moving and setting the appliance down

⚠ WARNING

To avoid crushing body parts, ensure these instructions are followed:

- Use suitable handling gear
- Move the appliance slowly and carefully, and secure it against tipping over
- Make sure centre of gravity is balanced and avoid jolts
- Ensure the supporting surface meets the requirements specified above

Risk of cuts from sharp edges

⚠ CAUTION

To avoid cuts, ensure personal protective equipment is used and exercise caution when handling sheet-metal parts.

Risk of trapping fingers or body in mechanical parts of the appliance

⚠ WARNING

To avoid this risk, when opening or closing the door, ensure that the handle is used and keep clear of the door hinges.

Risk of electric shock from live electrical parts

⚠ DANGER

Live electrical parts are to be found under covers, under the operating panel, along the mains power lead and on metal parts adjacent to the appliance. As such, work on the electrical system must only be performed by qualified electricians (as per EN50110-1 in EU or equivalent) from an authorised service company. To avoid risk:

- The appliance must not be installed or operated outdoors.
- The electrical supply must be connected in accordance with applicable local and national regulations and regulations of the professional associations and of the relevant power supply company.
- Ensure that all electrical connections are in perfect condition and fixed securely.
- Make sure that the appliance is connected to an equipotential bonding system (EU).



- If two microwave combination ovens are installed in a stacking kit, both cases of the appliances and the stacking kit itself must be grounded in a suitable manner and connected to an equipotential bonding system.
- For microwave combination ovens on a wheeled platform, the length of the mains power lead must accommodate the degree of movement allowed to the appliance by the retaining device on the wheeled platform. When moving the assembly (platform plus appliance), never place the mains power lead under tension.
- All electrical connections must be checked when the appliance is prepared for first-time use to ensure cables are laid correctly and connections are made properly.

1E. Hazards and safety precautions when preparing appliance for use

The information in this section should be read and understood by Facility Managers, Chefs, Users and Service Technicians.

Personal protective equipment requirement

Ensure work wear as specified in country-specific standards and directives for kitchen work is used, in particular:

- Protective clothing
- Heat protective gloves (compliant with EN 407 in European Union or equivalent)
- Safety boots

Safety precautions for preparation for first use

- Ensure cardboard packaging and transport securing devices etc. have been removed completely from the appliance.
- Ensure that any work on the electrical system is performed solely by a qualified electrician from an authorised service company.
- Ensure that the appliance, including all metallic accessories, is connected to an equipotential bonding system.
- Ensure all warning signs are in their designated position (Figure 1.1).
- Ensure all safety devices and protective equipment are fitted, are working correctly and are secured properly in place.
- Do not operate the microwave combination oven unless it has been properly transported, set up, installed and placed into operation as indicated in this manual and the person responsible for placing it into operation has confirmed this.
- Do not operate the oven if it is damaged. It is particularly important that the oven door closes properly and that there is no damage to the door, door hinges, door seals and sealing surfaces.
- If the appliance has wheels fitted to the supporting structure, the parking brakes on the front wheels must be engaged when operating the appliance.
- Ensure the air filter situated at the lower front of the appliance (Figure 1.2), is free of obstruction.
- Ensure the air outlets (Figure 1.2) are free from obstruction.



For details of ongoing safety precautions for everyday use, see *Section 1F: Hazards and safety precautions during operation*.



1F. Hazards and safety precautions during operation

The information in this section should be read and understood by Facility Managers, Chefs, Users and Service Technicians.

Personal protective equipment requirement

Ensure work wear as specified in country-specific standards and directives for kitchen work is used, in particular:

- Protective clothing
- Heat protective gloves (compliant with EN 407 in European Union or equivalent)
- Safety boots

General rules

- The appliance must not be operated outdoors.
- The appliance must not be shifted or moved during use.
- The appliance must not be operated without the air filter in place.
- The air filter must always be kept free of obstruction.
- The air outlets must be kept free from obstruction.
- Never hang dish towels or cloths on any part of the appliance.
- Never remove the external covers of the appliance.
- Never remove any fixed internal parts of the appliance.
- Never tamper with the control panel, door, seals, or any other part of the appliance.
- If the door or door seal is damaged, the appliance must not be operated until it has been repaired by a Service Technician.
- The door is a precision-made energy barrier with three microwave safety interlocks. Do not use it to support heavy objects.
- If the supply cord is damaged, it must be replaced by the manufacturer, a Service Technician or similarly qualified person to avoid a hazard.



If smoke is observed at any point, switch off the appliance. Unplug or isolate it from the electrical supply and keep the door closed in order to stifle any flames.

Restrictions on use



The restrictions listed in *Section 1B: General safety* must always be complied with.

Instructions for safe use of the appliance



Section 1B: General safety lists instructions for safe use of the appliance.



Potential risks during operation

Hot surfaces



There is a risk of burn if any of the interior parts of the cavity (Figure 1.2, item 11), the inside of the appliance door or any parts that are or have been inside the oven during cooking are touched. Ensure the personal protective equipment detailed at the beginning of this section is used.

Hot steam / vapour



Escaping hot steam and vapour can cause scalding to face and hands. When opening the door and when cooling the cavity using the 'Cool Down' function, step back from the appliance to avoid the hot steam and vapour escaping through the open door.

Excessive microwave energy



Precautions to avoid burns from excessive microwave energy:

- Do not attempt to operate the appliance oven with the door open, since open-door operation can result in harmful exposure to microwave energy. It is important not to defeat or tamper with the safety interlocks.
- Do not place any object between the oven front face and the appliance door or allow soil or cleaner residue to accumulate on sealing surfaces.
- Do not operate the appliance if it is damaged. It is particularly important that the oven door closes properly and that there is no damage to the door, door hinges, door seals and sealing surfaces.
- The oven should not be adjusted or repaired by anyone except properly qualified service personnel.

Break in the cold chain



To minimise risk of microbiological contamination of foods:

- Never use the appliance for temporary storage of food.
- Never intentionally interrupt the cooking process.
- Once the appliance is running again after a power failure, consider how the length of time taken to resume operation will affect the food condition. If in doubt, discard the food.



1G. Hazards and safety precautions during cleaning

The information in this section should be read and understood by Facility Managers, Chefs, Users and any other personnel charged with cleaning the appliance.

Personal protective equipment requirement

When cleaning the appliance cavity by hand, and using spray cleaning products, the following personal protective equipment should be used:

- Breathing mask
- Safety goggles
- Protective gloves
- Protective clothing/apron

The specification for these items is provided on the data sheet that should accompany the cleaning products themselves or, where necessary, from the manufacturer directly.

Other cleaning tasks should be carried out in accordance with the instructions given on cleaning and with the personal protective equipment specified by the manufacturer of the cleaning products.

General cleaning safety rules and requirements



See *Section 1B: General safety*. Full cleaning procedures are also detailed in the *Service and Repair Guide*.

Potential risks during cleaning

Risk of electric shock from live parts



Water on the exterior of the appliance can cause a short-circuit, which may result in electric shock on touching the appliance. Therefore:

- Do not spray the interior and exterior of the appliance with water.
- Always keep the USB cover closed during cleaning.

Risk of burns from high temperatures on interior parts of the appliance



There is a risk of burns should any of the following be touched:

- Any of the interior parts of the cavity.
- The inside of the appliance door.
- Any parts that are or have been inside the oven during cooking including racks, shelf grills and baking trays.

To minimise the risk of burns:

- Before starting cleaning tasks, wait until the cavity has cooled to below 50°C / 122°F or use the 'Cool Down' function to cool the cavity as described in *Section 2G: Cool down procedures*.



Risk of scalding from hot steam

⚠ WARNING

If water or cleaning agent is sprayed into the hot cavity, steam will be produced and this may scald. To minimise this risk:

- Before starting cleaning tasks, wait until the cavity has cooled to below 50°C / 122°F or use the 'Cool Down' function to cool the cavity as described in *Section 2G: Cool down procedures*.
- Step back from the appliance to avoid the hot steam and vapour escaping through the open appliance door.

Risk of irritation to skin, eyes and respiratory system from cleaning products

⚠ WARNING

Direct contact with the cleaning or protective chemicals will irritate the skin, eyes and respiratory system. To minimise this risk:

- Do not inhale the vapours or spray mist from the cleaning and protective chemicals.
- Do not let the cleaning or protective chemicals come into contact with skin, eyes or mucous membranes.
- Do not spray cleaning or protective chemicals into a cavity.
- Wear personal protective equipment as detailed at the beginning of this section.



Wearing personal protective clothing is vital throughout the cleaning process and can minimise risks of burns and scalds.

1H. Hazards and safety precautions during servicing and repair

The information in this section should be read and understood by Service Technicians.

Personal Protective Equipment

When repairing or servicing the appliance, ensure work wear and personal protective equipment is used as specified in applicable national regulations. The following personal protective equipment should be used:

- Protective gloves
- Safety boots
- Hard hat (e.g. when heavy loads are being lifted and working overhead)

Potential risks to move appliance

The potential risks associated with service and repair is the same as the possible risks you can be faced with during installation, as both processes may involve lifting and moving the appliance.

The risks are summarised below:

- Electric shock from live electrical parts
- Injury from lifting incorrectly
- Trapping fingers or body in mechanical parts of the appliance
- Cuts from sharp edges
- Crushing if the appliance tips over or falls off





Further information on the above risks and the procedures to avoid them are detailed in *Section 1D. Hazards and safety precautions during installation and setting up.*

Rules for moving and setting up the wheeled trolley safely

The appliance may need to be moved for service and repair. To avoid hazards, the following rules must be observed when moving the wheeled trolley (optional accessory) that carries the appliances:

- Watch out for all connecting cables when moving appliances. Never wheel over the connecting cables. Never pull off or even stretch the connecting cables.
- The appliances must be disconnected from the electrical supply before moving the stacking kit (optional accessory).
- The appliances must be left to cool down on the trolley before being moved.
- There must not be any food left in the appliances.
- The appliance door must be closed.
- Protective clothing must be worn if the appliance is mounted on a trolley.
- It is important to ensure that the unit is level once it is back in place.
- Once the unit is back in place, the parking brakes must be engaged again.
- Whatever the position, care must be taken to ensure that the trolley carrying the appliance does not tip over.

Risk of burns

WARNING

Before starting servicing and repair work, wait until the cooking chamber has cooled to below 50°C / 122°F or use the 'Cool-Down' function (*Section 2H: Cleaning Procedures*) to cool the cooking chamber.

Wear personal protective equipment suitable for handling hot surfaces before touching any of the interior parts of the cooking chamber, the inside of the appliance door or any parts that were inside the oven during cooking.

Risk of burns from microwave emissions

- Do not become exposed to emissions from the microwave generator or parts conducting microwave energy.
- Never operate an appliance that has failed the 'Microwave Leakage test'.

Risk of smoke or fire

If one of the electrical components is defective, for example due to a short-circuit, or if the internal wiring is refitted incorrectly when servicing/repairing the oven, there is a risk of smoke or fire. To avoid this risk:

- Never use electrical spare components which failed a dedicated test or look damaged.
- Carefully refit electrical connections using the wiring diagrams provided in the *Service and Repair Guide*.



11. Hazards and safety precautions when taking the appliance out of service

The information in this section should be read and understood by Facility Managers and Service Technicians or other suitably qualified service engineer.

Personal protective equipment

When disconnecting the appliance, ensure work wear and personal protective equipment is used as specified in applicable national regulations.

When moving the appliance, ensure the following personal protective equipment is used:

- Protective gloves
- Safety boots
- Hard hat (e.g. when heavy loads are being lifted working overhead)

General precautions

- The kitchen floor must always be kept dry to reduce the risk of accidents
- The appliance door of the microwave combination oven must be closed before disposing of the appliance
- Do not leave food in the cavity

Potential risks

Risk of electric shock from live parts and loose cables



When the safety cover is open, there is a risk of electric shock from touching live parts. Make sure that any work on the electrical system is performed solely by a qualified electrician from an authorised service company.

Risk of injury from lifting incorrectly



Risks associated with lifting incorrectly and how to avoid injuries are detailed in *Section 1D: Hazard and Safety Precautions during installation and setting up*.

Risk of crushing if the appliance tips over or falls off



See *Section 1D: Hazard and safety precautions during installation and setting up* for details on minimising risks associated with the appliance tipping over.



Section 2: Operations and Installation



2A. Introduction to e1s

The Merrychef eikon e1s microwave combination oven offers you the flexibility of combination cooking with additional control over fan speed and microwave power.

Combination cooking enables high quality results to be achieved in a fraction of the time taken by conventional cooking, particularly when baking, browning, roasting and grilling dishes.

Once established, precise instructions for combination or convection cooking of selected items may be programmed into the oven's memory so that they can be repeated easily and accurately. Up to 1024 programmes can be stored and simply recalled.

The oven controls offer even greater flexibility by allowing multistage programming. This enables the exact conditions required for quality results to be set according to the food type. A single cooking programme can have up to six stages, each stage controlled with its own time, fan speed and microwave power settings.



Figure 2.1: e1s oven front view

Identifying your microwave combination oven

The following information is included at the rear of the oven on the name plate:

- Brand and name (Merrychef)
- Model range (e1s)
- Model number
- Serial number
- Supply voltage
- Maximum phase current
- Maximum supply power
- Output microwave power
- Output convected power
- Microwave frequency
- Manufacturer
- Manufacturing site
- Brand headquarters

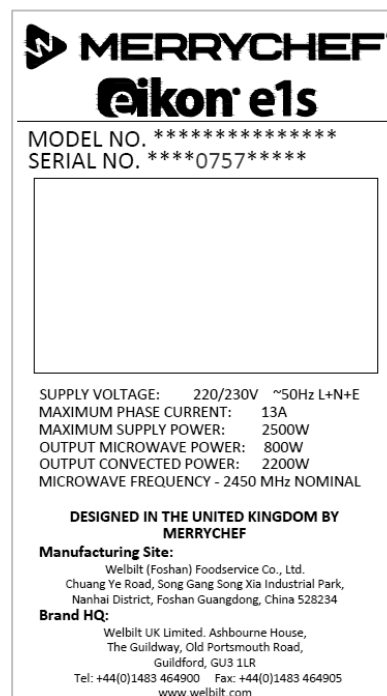

Figure 2.2: e1s name plate

Appliance parts and their functions

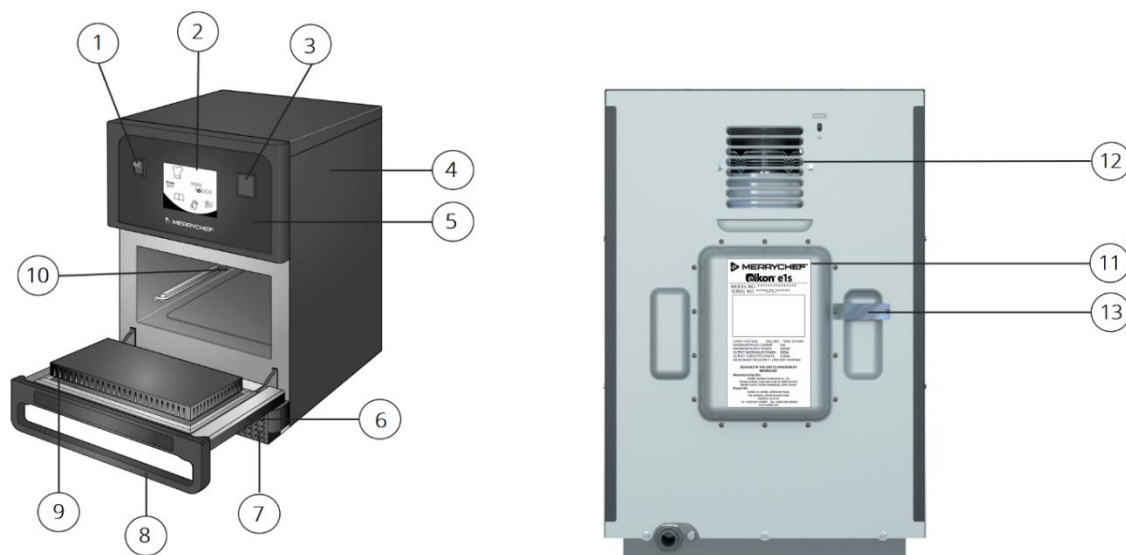

Figure 2.3: Appliance parts and their functions

- 1) **ON/OFF appliance switch** – Used to turn the microwave combination oven on and off. Turning this switch off does not isolate the appliance from the electricity supply.
- 2) **easyTouch® screen control panel** – When the appliance is switched on, the easyTouch® screen illuminates the user interface.
- 3) **USB port** – A USB socket located under the cover allows updates to programmes stored on the appliance.
- 4) **Protective cover** – The cover can only be removed with specific tools. It prevents live parts from being touched accidentally and prevents access to the moving fan. Always ensure the cover is securely in place.
- 5) **Operating panel** – Prevents live parts from being touched accidentally. Always ensure the panel is in place.
- 6) **Appliance door** – This is a precision-made energy barrier with three microwave safety interlocks. Always keep it clean and do not use it to support heavy objects.
- 7) **Air filter** – Situated at the lower front of the appliance, the air filter is part of the ventilation system. Keep it free of obstruction and clean it daily as described under *Section 2G: Cleaning procedures*.
- 8) **Door handle** – A rigid bar which is pulled downwards and away from the appliance to open it.
- 9) **Door seals** – Ensure a tight seal around the door. Always keep them clean and check regularly for signs of damage.
- 10) **Cavity** – Also known as the cooking chamber, the cavity is constructed from stainless steel and used for cooking products.
- 11) **Nameplate** – A plate on the rear of the oven that states the serial number, model type and electrical specifications.
- 12) **Air outlets** – On the rear and are used to cool internal components and allow steam from the cavity to escape. The air outlets must be kept free from obstruction and they will not allow microwave energy to escape into the environment.
- 13) **Steam pipe and cover** – A covered pipe from the cavity to the back of the oven to vent steam during cooking and prevent pressure build up.



Equipment and accessories supplied

The e1s microwave combination oven is supplied with the following equipment and accessories.

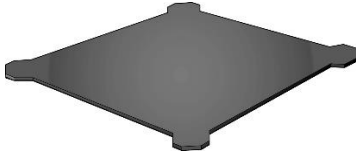

Cook plate

The cook plate sits inside the appliance and food is placed on top of it using suitable liners or baskets. It is removable for cleaning.

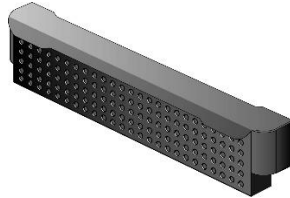

Air filter

The air filter situated at the lower front of the appliance is part of the ventilation system and should be kept clean and free of obstruction.

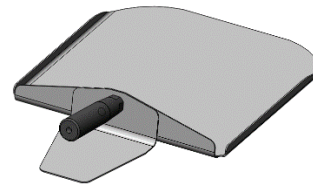

Paddle

The paddle is used to remove food from the oven.



There are a number of other optional Merrychef accessories that customers can purchase to use with the microwave combination oven. Contact Merrychef suppliers for more information.



2B. Installing the appliance



Users must read *Section 1: Safety Guide* before installing or using the microwave oven.

Unpacking

1. Cut the box banding straps and remove the lid.

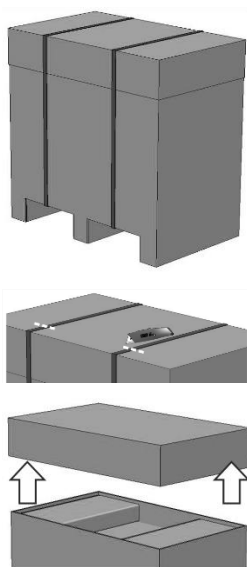

2. Remove the customer documentation and any product accessories:

- 1x air filter
- 1x cook plate
- 1x Operations and Installation Guide

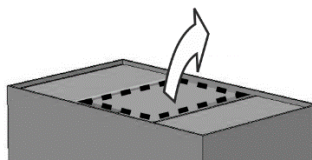

3. Remove the packaging to reveal your microwave combination oven.

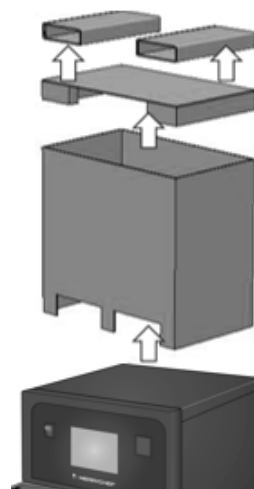

Inspect the appliance for damage before signing the delivery note. Record any damage on the delivery note and notify the carrier and manufacturer.



WARNING Never install or put into service a damaged appliance under any circumstances.

Taking the appliance off the pallet

1. Identify appropriate lifting points.



- Wear appropriate Personal Protective Equipment.
- **Do not lift the oven by the handle.**
- Risk of crushing from the appliance tipping over. Take precautions.

2. Lift the appliance from the packaging. The appliance is now ready for installation.

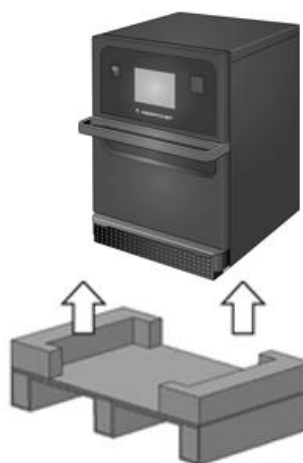

Installation location requirements

Minimum space required

Figure 2.4 shows the space required to install the appliance. It also shows the minimum horizontal distances from adjacent walls and surfaces. The safety clearance on the top must also always be complied with.

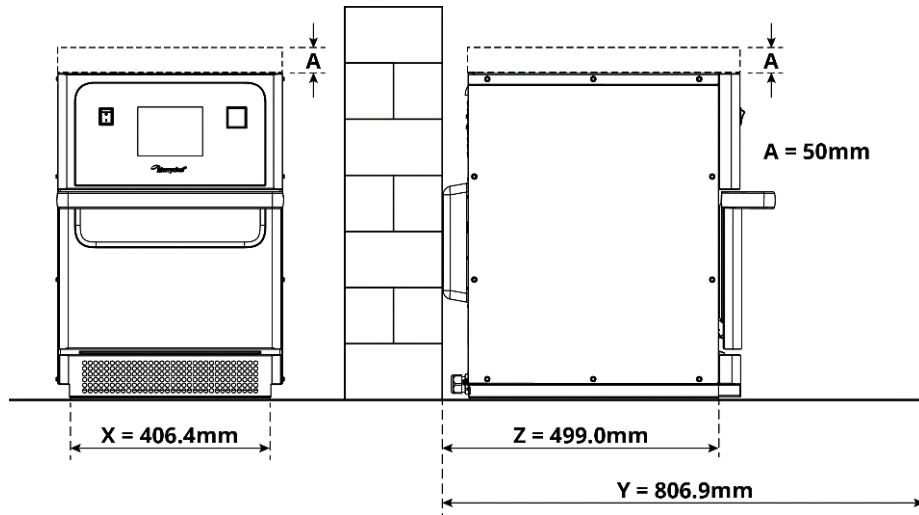

Figure 2.4: Minimum space requirements

- Safety clearance from the top (A) = 50mm (2")
- Depth requirement:
 - Width of appliance (X) = 406.4mm (16")
 - Total depth with door open (Y) = 806.9mm (31.8")
 - Counter depth (Z) = 499.0mm (19.6")
- Safety clearance on left-/right-hand side / at rear: 0mm

Actual space requirements

Far more room than the specified minimum space requirement is needed in front of the appliances to operate the microwave combination ovens safely, in particular to handle hot food safely. Larger wall gaps are generally recommended to provide access for servicing.

In the installation location, the following parts must not be covered, adjusted or blocked:

- Air vent on the rear of the appliance
- Air filter at the front of the appliance

Mounting the appliance on a work surface

The appliance can be mounted on a suitable work surface that can bear the weight.

Observe the following rules to ensure that the appliance is installed in a stable situation:

- The worktop must have a non-slip surface.
- The supporting surface must have the following properties:
 - The supporting surface must be flat and level.
 - The supporting surface must be able to bear the in-use weight of the appliance, plus the weight of the structure supporting the appliance as follows: 50Hz = 46kg / 101lbs and 60Hz = 45kg / 99lbs.

Electrical installation requirements

Safety rules

⚠ DANGER Observe the following rules to prevent hazards caused by faulty electrical connections:

- Only electricians qualified under the terms of EN 50110-1 and from an authorised service company are permitted to perform work on electrical equipment.
- The electrical supply must be connected in accordance with applicable local regulations of the professional associations and of the relevant power supply company.
- The case of the appliance must be grounded in a suitable manner and connected to an equipotential bonding system.
- If two microwave combination ovens are installed in a stacking kit, both cases of the appliances and the stacking kit itself must be grounded in a suitable manner and connected to an equipotential bonding system.
- Wear the personal protective equipment as specified in *Section 1D*.

Equipment provided by customer and electrical installation regulations

Table 2.1 shows what equipment must be provided by the customer and what regulations must be observed when connecting the appliance.

| Equipment | Regulations |
|-------------------------------|---|
| Fuse | Fuse protection and connection of the appliance must comply with local regulations and national installation requirements. |
| Equipotential bonding | The appliance must be incorporated in an equipotential bonding system. Equipotential bonding: electrical connection that ensures that the frames of electrical equipment and any external conductive components are at an equal (or practically equal) potential. |
| Residual-current device (RCD) | The installation regulations require protection by a residual-current device (RCD). Suitable residual-current devices meeting the relevant national regulations must be used. If the installation includes more than one appliance, one residual-current device must be provided for each appliance. |
| Disconnection device | An easily accessible all-pole disconnection device with a minimum contact separation of 3mm must be installed close to the appliance. The appliance must be connected via this disconnection device. The disconnection device is used to disconnect the appliance from the electrical supply for cleaning, repair and installation work. |

Table 2.1: Electrical equipment and regulations

The requirements and specifications for e1s

Fitted frequency converter

- The appliance is fitted with one frequency converter (FC) and an EMC mains input filter.
- These devices may result in a leakage current of more than 3.5mA per FC drive.
- Use a suitable RCD for the rated voltage.



Properties of the residual-current device

The residual-current device (RCD) must have the following properties:

- Filter for filtering out RF currents.
- 'Time delayed' trip characteristic for RCD devices with trip threshold >30mA: prevents RCD being tripped by charging currents of capacitors and parasitic capacitances when appliance is switched on.
- 'Leakage current protection, Type SI' trip characteristic for RCD devices with trip threshold >30mA: insensitive to nuisance tripping.

Circuit Breakers

- Establishments with standard (Type 'B') circuit breakers are sensitive to 'surges' which occur on switching on freezers, refrigerators and other catering equipment, including microwave combination ovens. Because of this, a Type 'D' circuit breaker (designed specifically for this type of equipment) must be fitted. An individual, suitably rated circuit breaker should be fitted for each appliance installed.

Low impedance electrical supply

- This commercial combination microwave oven complies with EN 61000-3-11. However, when connecting sensitive equipment to the same supply as the appliance, the user should determine in consultation with the supply authority, if necessary, that a low impedance supply is used.

Electrical supply

- The e1s microwave combination oven is only available as a single-phase model and is designed to draw 13 amps maximum in all configurations, as shown in Table 2.2.

| Illustration | Meaning |
|------------------------------|---|
| <p>UK / EU</p> | <p>Phase: Single</p> <p>16 A Breaker for 15/16 A plug configurations and be Time Delay, Motor Start Type (European Type D).</p> <p>UK 13 A models are fitted with a moulded plug to BS1363, fused at 13A. EU13 A models are fitted with a moulded plug to CEE 7/7 (Type F Schuko) rated at 16 A.</p> <p>ROW 13 A models are fitted with country specific 15/16 A plugs.</p> <p>Please contact your local Welbilt representative for further information.</p> |
| <p>Latin / South America</p> | |
| <p>China</p> | |

Table 2.2: e1s electrical specifications

Equipotential bonding

- An equipotential bonding point is provided on the rear panel of the appliance for independent Earth (GND) connection.



2C. Getting started



Before turning on the oven, users must read *Section 1E: Hazards and safety precautions when preparing appliance for use.*

Fitting the air filter

The air filter is fitted in position below the cavity door. It is a magnetic attachment.



Inserting the cook plate

The cook plate is inserted in the cavity, simply by sliding it onto the shelf runners.

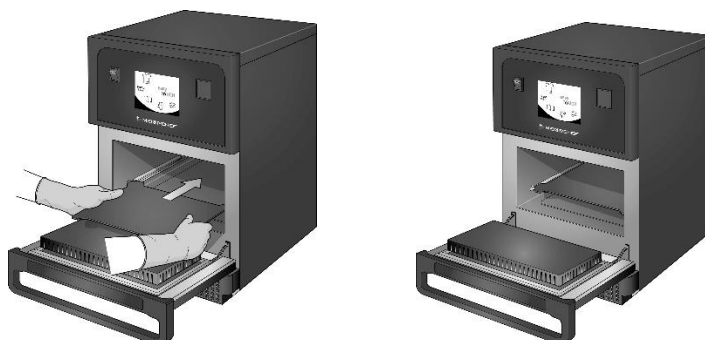

Turning the oven on and off

To start up the oven, ensure the appliance is clean and empty with just the cook plate inside it. Then switch the appliance on using the on/off switch at the front of the oven.



When the oven is switched on, the easyTouch[®] screen illuminates with the display briefly showing the serial number and appliance data. To keep the data on the screen, lightly tap the screen to freeze the display. Tap again to continue.



Settings on first usage

The system is preconfigured with all the required settings to start cooking immediately following installation. However, you may want to configure the following before using the oven.

- Date and time
- Alarms
- Temperature
- Oven time

Settings are changed by selecting the 'settings' screen which is accessible from the main menu.

However, the main menu is only displayed after the oven is pre-heated and therefore, if you want to change settings before or whilst the oven is heating, for example before first usage, do as follows:

- 1) Tap to hold the first screen upon switching on, which shows the serial number.
- 2) Press the hidden button at the top right-hand corner to load the password screen.

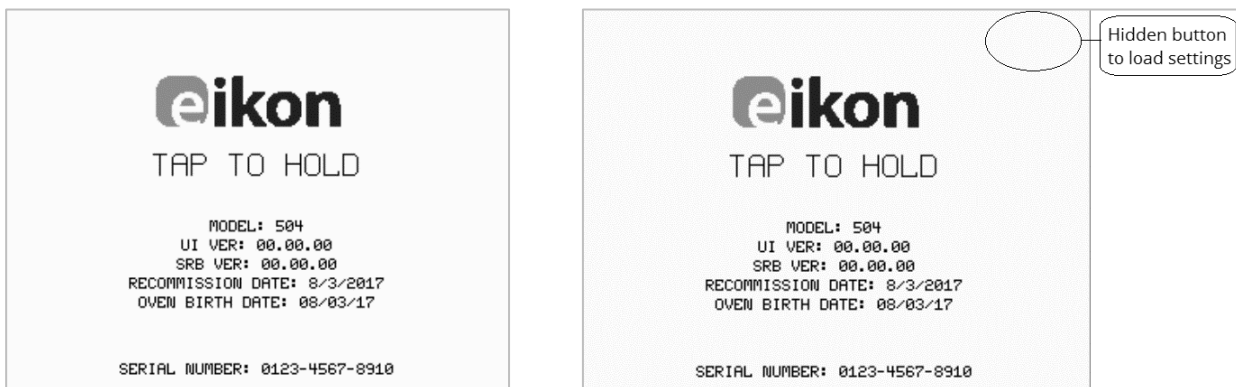

- 3) Enter the administration password. The default password is 'MANAGER'.
- 4) Select the required settings icon to make changes as required.

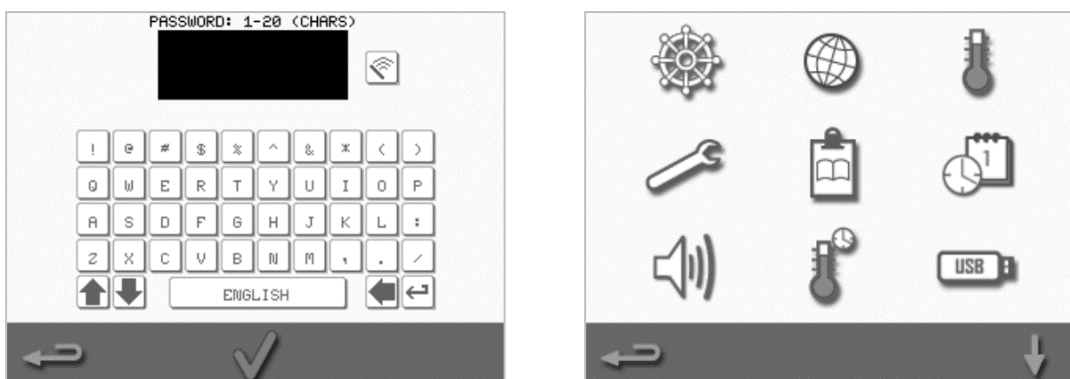

See *Section 2F: Changing settings* for instructions.

Selecting suitable utensils

You may want to ensure you have suitable utensils before using the oven. Only use utensils that are suitable for use in microwave combination ovens. Check the manufacturer's instructions and temperature rating to determine the suitability of individual containers or utensils.

Table 2.3 provides general guidelines:

| Cooking utensils | Permitted | Notice |
|---|-----------|---|
| Heat resistant containers | | |
| Toughened glass | YES | |
| Compatible vitreous ceramics | YES | Do not use items with metallic decoration |
| Earthenware (porcelain, crockery and china) | YES | |
| Metals, foils and plastics | | |
| Metallic and foil trays and containers | NO | |
| Dual-ovenable plastic containers | YES | Use only containers approved by the manufacturer |
| Disposables | | |
| Combustibles (paper, card, etc.) | YES | Use only combustibles approved by the manufacturer |
| Other utensils | | |
| Tie tags | NO | |
| Cutlery | NO | Do not leave utensils in a food product while it is cooking |
| Temperature probes | NO | |

Table 2.3: Suitable utensils

Preheating the oven

The oven will automatically preheat to the set temperature when it is switched on. However, if the appliance is set up with two or more preheating temperatures, a choice is displayed when the oven is switched on. Select the required temperature.



You may see a scroll arrow at the bottom of the screen which indicates that there are more temperature choices.

During preheating, the display shows the progress as the cavity heats up to the set temperature. To stop the cavity heating up, touch the red 'X' symbol at the bottom of the screen.

The appliance is ready to use when either the cookbook or main menu is displayed.

If the cookbook is displayed, press the Backspace button in the bottom left-hand corner of the screen to display the main menu.

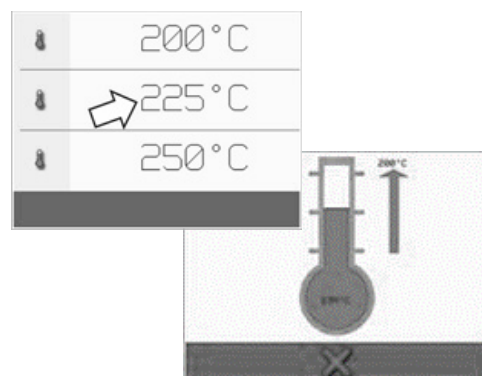

Understanding the main menu and keyboard



Main menu



Keyboard



The easyTouch® screen display, layout and icons shown herein are for guidance purposes only and are not intended to be an exact representation of those supplied with the appliance.

| Button | Meaning | Function |
|------------------|------------------------|--|
| Main menu | | |
| | Development Mode | 'Development Mode' enables multistage cooking profiles to be developed, then stored under a name and symbol for reuse. |
| | Press&Go | 'Press&Go' allows quick access to use the cooking profiles that are already stored. |
| | Cookbook | 'Cookbook' contains the cooking profiles stored in the memory of the appliance. |
| | Cleaning / Temp change | 'Cleaning / Temp change' allows the cavity temperature to be changed and the appliance to be prepared for cleaning. |
| | Settings | 'Settings' are used to control the appliance settings and functions and for service and maintenance purposes. |
| Keyboard | | |
| | Keyboard screen | The 'keyboard screen' is used to enter password and to insert data for programmes. |
| | Clear screen | Select the 'clear screen' key to delete text from the keyboard screen. |
| | Keyboard | Use the 'keyboard' to type in text. |
| | Spacebar | Select the 'spacebar' key to insert a blank. |
| | Return | Select the 'return' key to start a new line. |
| | Keyboard scroll | Select the up/down arrows to scroll the keyboard screen. |
| | Enter / OK | Select the green tick to confirm settings and continue. |
| | Previous screen | Select the 'backspace' key to return to a previous screen. |

Table 2.4: Main menu and keyboard items

Character length

- Use 1-20 characters in two lines max for names of cooking profiles, cooking profile groups and passwords.
- Use 1-54 characters in five lines max for stage instructions of individual cooking profiles.



2D. Cooking procedures

How to cook

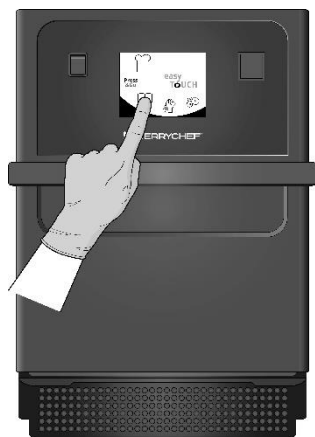

1. On a preheated oven, select a cooking profile from the cookbook or enter a new cooking profile.

See Section 2E for instructions on how to enter a new cooking profile.

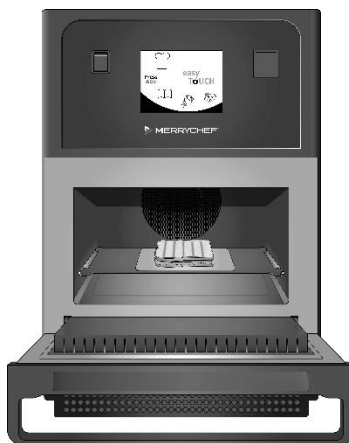

2. Open the appliance door and place the prepared food on the cook plate.

⚠ WARNING Hot surface

Ensure all packaging has been removed.



3. Close the appliance door again.

The cooking process will automatically start if the programme was selected in step 1. Alternatively, the programme can be selected or changed at this stage.



4. Wait for the cooking process to finish. An audible signal is given when the cooking process is finished. Follow the prompts displayed by the software.

Do not open the oven door while the food is cooking.

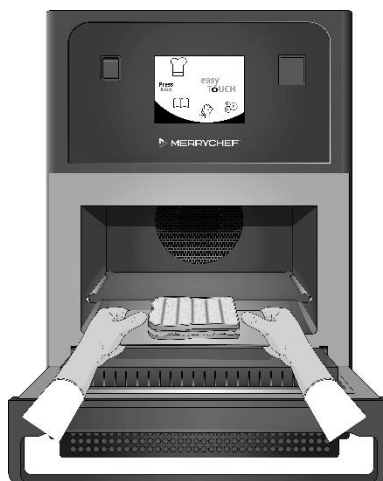

5. Open the appliance door and take the food out.

⚠ WARNING Hot surface

Do not remove cook plate unless cleaning.

Never leave food in the oven, as it will continue cooking.



6. Close the appliance door again after taking the food out.

The cooking programme is reset now and a new cooking profile can be selected to use the oven again.



Using a cooking profile - quick serve mode

1. Select the 'cookbook' symbol  from the main menu screen and then select the All Menus option.



2. Use the scroll up/down arrows to find the cooking profile.

Note: If a picture has a red frame around it, this means the cavity temperature is set too high or too low for that cooking profile. The cavity temperature will need to be changed to use that option. See Changing cavity temperature.



3. Select the required cooking profile to start cooking. For example: 'ITALIAN SUB x 1'.



4. Follow any instructions on the screen, if displayed, and press the green tick to start the cooking process.

Note: If food has not been placed in the oven, at this stage open the oven door and place it on the cook plate and then press the green tick.

⚠WARNING Hot surfaces at the door and in the cavity.



5. The cooking time counts down for each stage. When the cooking profile ends, a red bar is displayed usually with an audible sound. Open the door or touch the red 'X' to return to the cooking profile.

Note:

- Opening the appliance door during cooking stops the cooking profile and displays a warning. Avoid opening the door during the cooking process.
- Closing the door, however, allows the user to continue or cancel the cooking profile.



Using a cooking profile – full serve mode

1. Select the 'cookbook' symbol  from the main menu screen and then select a group of cooking profiles, for example 'ITALIAN SUBS', to display the individual cooking profiles.

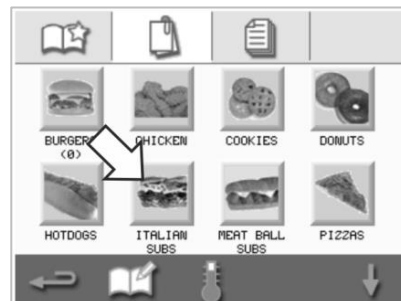

2. Select a cooking profile from the options available in the selected group, for example 'ITALIAN SUB x 2'.



3. Follow any instructions on the screen, if displayed. Press the green tick to start the cooking process.

Note: If the product has not been placed in the oven, at this stage open the oven door and place the food on the cook plate and then press the green tick to start cooking.

⚠WARNING Hot surfaces at the door and in the cavity.



4. The cooking time counts down for each programme stage. When the cooking profile ends, a red bar is displayed usually with an audible sound. Open the door or touch the red 'X' to return to the cooking profile.

⚠WARNING Hot surfaces at the door and in the cavity.

Note:

- To check the cavity temperature when cooking, lightly tap the temperature displayed. The cavity temperature is shown with an asterisk.
- Opening the appliance door during cooking stops the cooking profile and displays a warning. Avoid opening the door during the cooking process.
- Closing the door, however, allows the user to continue or cancel the cooking profile.

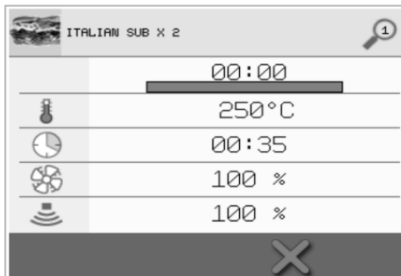
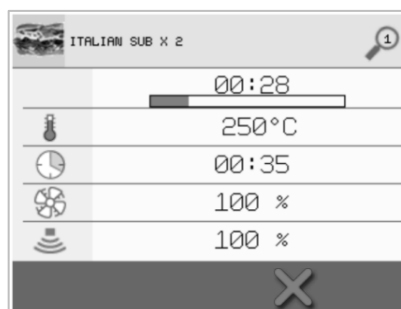

Choosing cooking profiles for Press&Go menu

1. Select 'Press&Go'  from the main menu screen, and then select the 'edit cookbook' symbol.

Two lists are displayed.

- The list on the left shows the cooking profiles that are part of the 'Press&Go' menu.
- The list on the right shows other cooking profiles that are available.

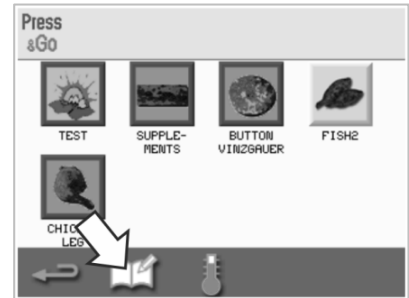

Both lists can be scrolled up or down using the blue arrows on the right of each list.

2. Select a cooking profile from the list on the left.
 - Choose whether to change its position within the list or to remove it into the list on the right.
 - To change the order of cooking profiles in the left list, use the blue up/down arrows in the middle.
 - To move a selected cooking profile to or from the 'Press&Go' menu, use the green/red arrows in the middle.
 - To make a cooking profile from the right list available in the 'Press&Go' menu, move it into the left list.

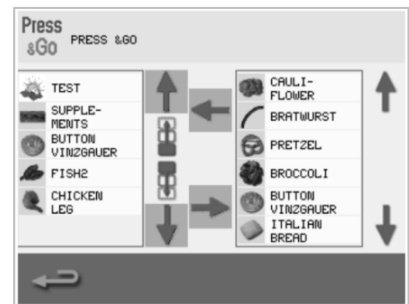

3. Select backspace to return to the 'Press&Go' menu screen when finished.

Running a cooking profile from the Press&Go menu

1. Select 'Press&Go'  from the main menu screen and then select the cooking profile required to cook.

Note: Follow any instructions on the screen, if displayed. If the product has not been placed in the oven, at this stage open the oven door and place the food on the cook plate and then press the green tick to start cooking.



2. The display shows the cooking time countdown. The timer bar turns red to indicate that the cooking cycle has finished.



Changing the cavity temperature

You may need to change the cavity temperature depending on the food you are cooking. If the cavity temperature is set to a value unsuitable for a cooking profile, it will need to be changed before that cooking profile can be used. Cooking profiles unsuitable for the set temperature are highlighted with a red border.

To change the cavity temperature:

1. Take note of the cavity temperature required for the cooking profile and then press the green tick to continue.

Note: You can find out the required temperature by selecting a cooking profile highlighted with red border.



2. Select the 'temperature' symbol in the selected cooking profile screen.



3. An asterisk next to the temperature value indicates the present cavity temperature. Select the required cavity temperature for the cooking profile.



2E. Cooking profiles

Creating a cooking profile

1. Enter development mode

Select the 'chef's hat' symbol from the main menu screen to enter development mode.



2. Set the microwave power

The temperature value displays the set preheating temperature. To change the temperature, select the 'temperature' symbol, and enter a value within the limits displayed.

Select the green tick to continue.

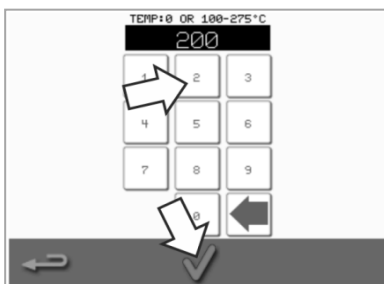
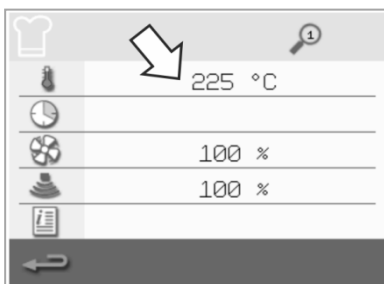

3. Set the cooking time

Select the 'clock' symbol and enter the cooking time for each stage up to a maximum of 10 minutes.

Example: Enter 110 = 1 minute and 10 seconds.

Select the green tick to save the inserted value.

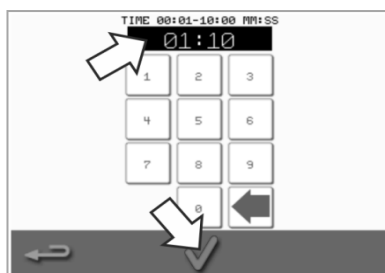
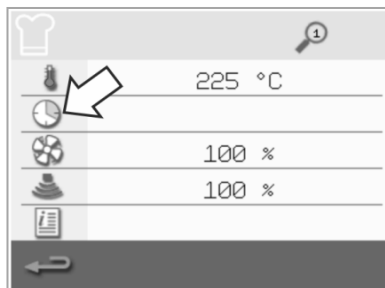

4. Set the microwave power

Select the 'microwave' symbol and set the microwave power (0 and 5-100%).

Select the green tick to save the inserted value.

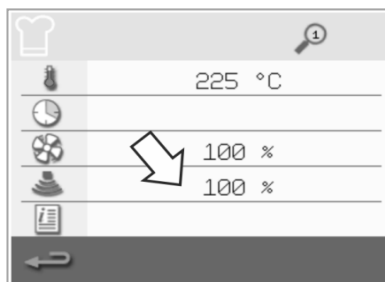

5. Set the fan speed

Select the 'fan' symbol and set the fan speed within the limits shown on the screen.

Select the green tick to save the inserted value.

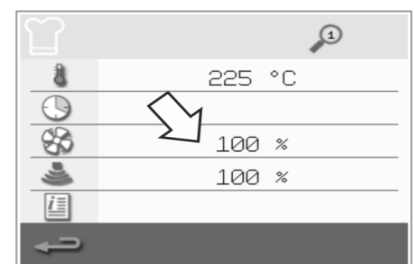

6. Enter instruction for a stage (optional)

Select the 'information' symbol to enter instruction for a stage.

Example: 'Stage 1 - place a food product into the cavity'.

Select the green tick to save the inserted instruction.

Select the right arrow with a 'plus' symbol at the bottom to add a new stage by repeating the steps above.

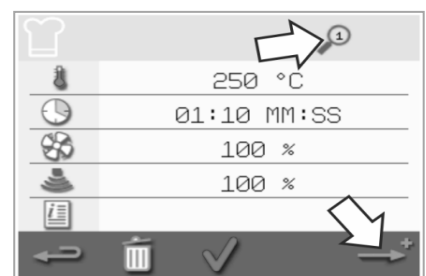

Note:

- Cooking profiles can have up to a maximum of six stages.
- The 'magnifier' symbol at the top indicates which stage is displayed.
- Select the left/right arrow at the bottom to shift between the stages.

Viewing and editing cooking profiles

1. Select the 'cookbook' symbol from the main menu screen.



2. Select the 'All menus' symbol from the cookbook screen.

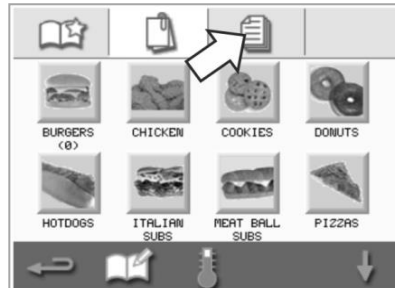

3. Select the 'edit cookbook' symbol.

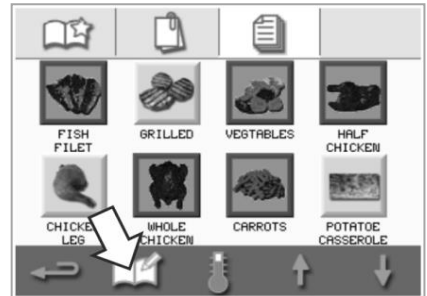

4. Use the up/down scroll arrows to find the cooking profile.

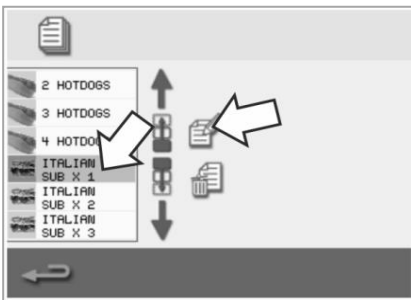

5. Select the 'view/edit cooking profile' symbol.

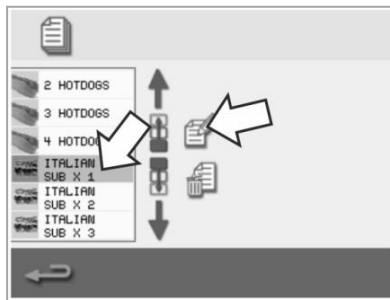

6. View or adjust the cooking profile as required.

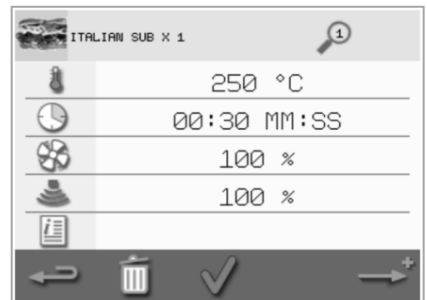

See *Creating Cooking Profile* for instructions on how to change cooking profile entries.

Moving a cooking profile in a group of cooking profiles

1. Select the 'cookbook' symbol from the main menu and select the group of cooking profile to move, e.g. 'ITALIAN SUBS'.

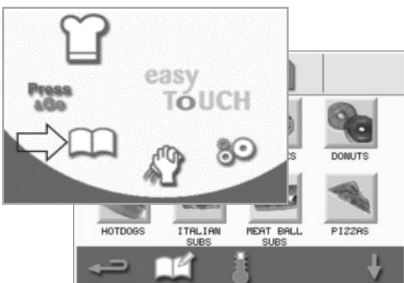

2. Select the 'edit cookbook' symbol in the selected cooking profile screen.

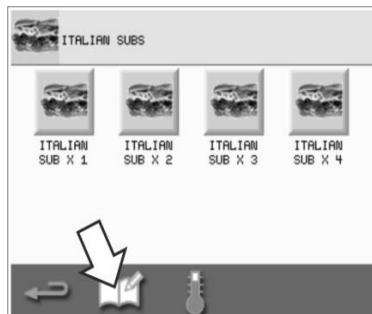

3. Select the cooking profile to move and use the smaller up/down arrows to move it within the group.

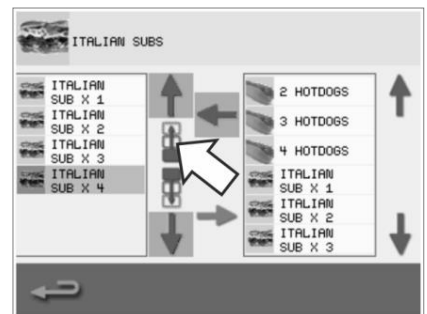

Moving a cooking profile in a list

1. Select the 'cookbook' symbol from the main menu screen and then select the 'edit cookbook' symbol in the cookbook screen.

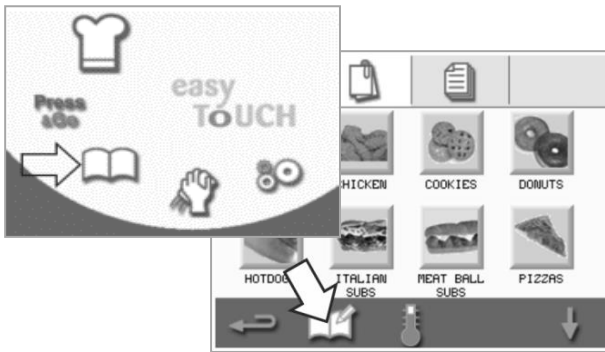

2. Use the big scroll arrows to locate cooking profile groups and then use the small arrows in the centre of the screen to move the selected cooking profile within the list. Use backspace to return to the cookbook screen.

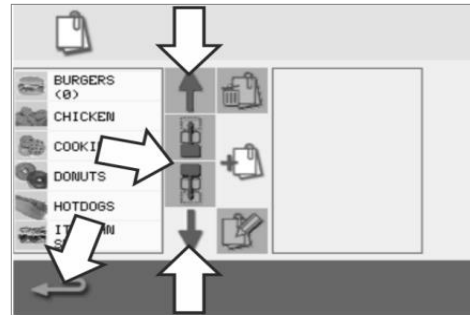

Adding a new cooking profile group

1. Select 'cookbook' from the main menu screen.
2. Select the 'edit cookbook' symbol from the cookbook screen.
3. Select the 'add a new cooking profile group' symbol.

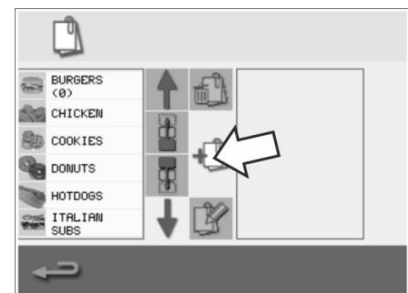
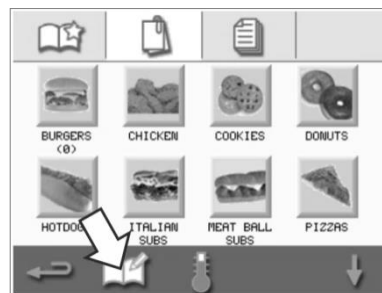

4. Select the 'camera' symbol to open a database of pictures.
5. Select a picture for the cooking profile group. You can use the scroll arrows at the bottom of the screen for more pictures.
6. Enter a name for the new cooking profile group (max. 20 characters) and press the green tick to save it.

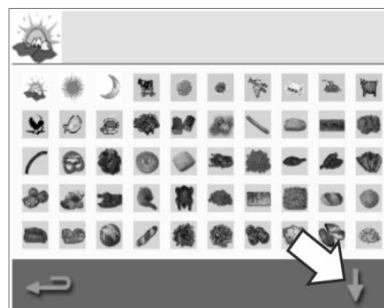
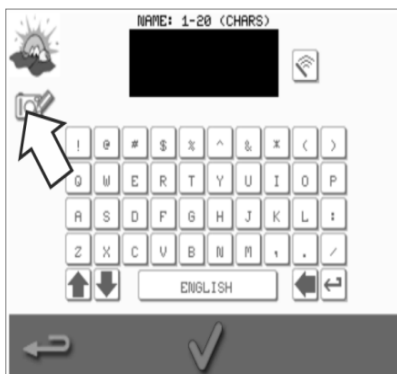

Adding a cooking profile to a group of cooking profiles

1. Select 'cookbook' from the main menu screen.
2. Select the cooking profile group you want to add to.
3. Select the 'edit cookbook' symbol in the cooking profile screen.



4. Use the up/down scroll arrows on the right to find and select the cooking profile you want to add.
5. Select the green 'left' arrow to add the selected cooking profile, which will now be listed on the left.

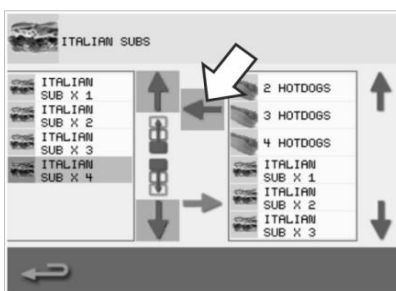
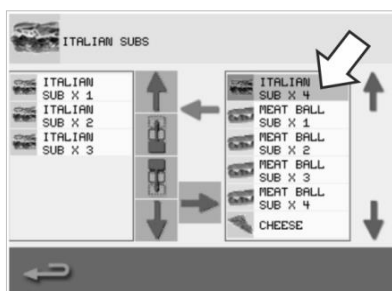

Deleting a cooking profile group

1. Select 'cookbook' from the main menu screen.
2. Select the cooking profile group to delete.
3. Select the 'edit cookbook' symbol.

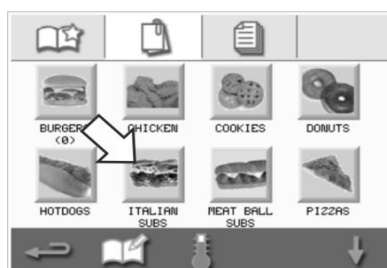

4. Select the 'delete cooking profile group' symbol.
5. Select the green tick to delete the cooking profile group.

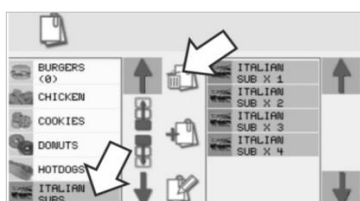

Editing a selected cooking profile group name

1. Select 'cookbook' from the main menu screen.



2. Select the 'edit cookbook' symbol from the cookbook screen.

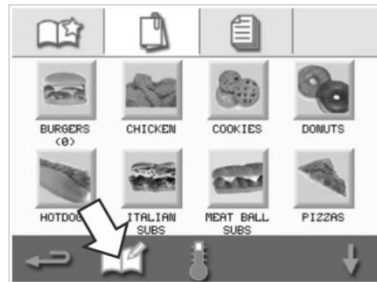

3. Select the cooking profile group that you want to edit.

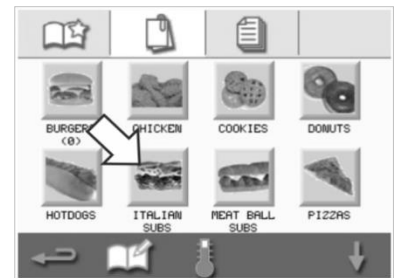

4. Select the 'edit cooking profile group' symbol.

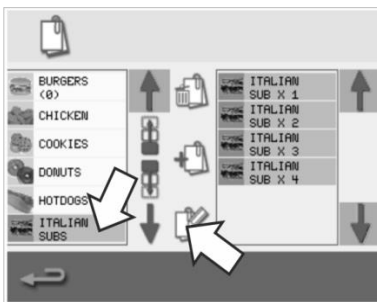

5. Enter the new name of the cooking profile group and select the green tick to continue.

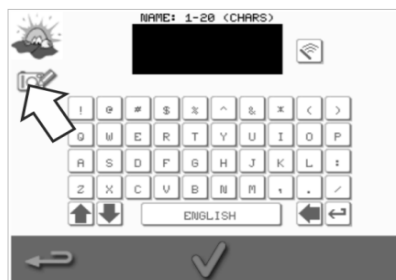

2F. Changing settings

Changing settings process

1. Select the 'settings'  symbol from the main menu screen.

Note: The main menu is displayed after the oven is pre-heated. If you want to change settings without pre-heating the oven, for example change settings before first usage, you should tap the first screen to hold it and then press the hidden key at the top right-hand corner to load the password screen, shown in step 2.



2. Enter your password and select the green tick to display the 'settings' options.

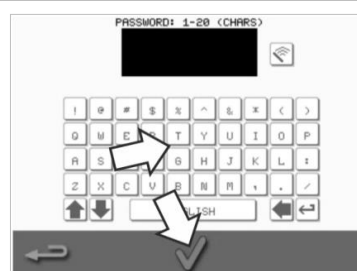

3. Make changes as required. Use the up/down scroll arrows at the bottom of the screen to display all functions of the 'settings' menu.

The 'settings' menu comprises the following functions:

- A. Operating mode / navigation settings
- B. Language options
- C. Cavity temperature settings and labels
- D. Service information and error logs
- E. Cooking profile counters
- F. Date and time settings
- G. Speaker and sound level settings
- H. Timer (Temperature / ON / OFF)
- J. USB programme downloads
- K. Temperature band settings
- L. Change settings / service access passwords
- M. Screen saver

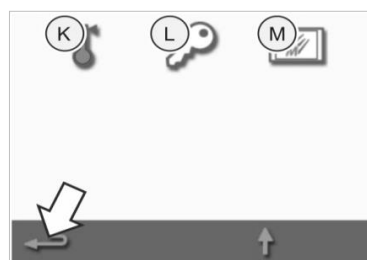
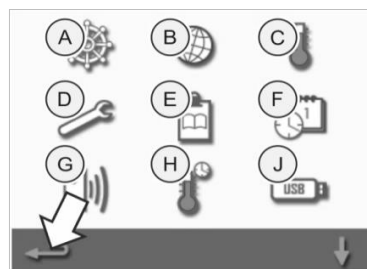

When finished with a setting, select backspace to return to the main settings menu to make other changes.

4. Press the backspace button to exit the 'settings' menu. A prompt appears to either 'SAVE' or 'DISCARD' any changed settings.



Operating mode / navigation settings

1. Select the 'operating mode/navigation' symbol from the settings menu.

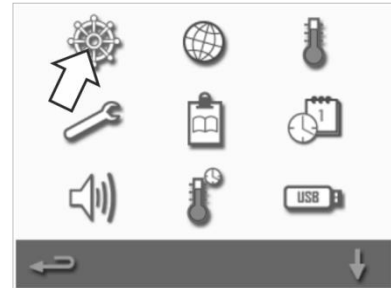

2. Select 'QUICK SERVE MODE' for cooking only.
Select 'FULL SERVE MODE' for creating cooking profiles.
Select 'MANUAL MODE' to manually cook only via the 'chef's hat' symbol on the main menu screen.
Select 'ENABLE SETTINGS' to display an 'unlock' symbol on the 'Quick Serve Mode' screen to allow access to the 'settings' menu.

Note: If a green tick is displayed, the corresponding function is active.

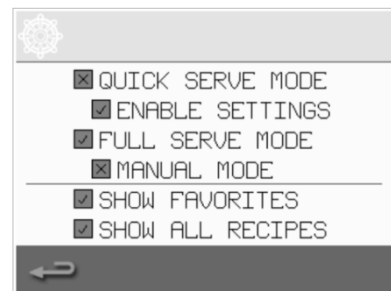

3. Select 'MAGNETRON ENERGY DELAY' to enable a magnetron warm up period for all cooking profiles.

Select 'ENERGY SAVING' to enable the hibernation mode when the oven is inactive.

Language settings

1. Select the 'globe' symbol from the settings menu



2. Select the checkbox(es) of the required language(s) from the list shown.



Cavity temperature settings and labels

1. Select the 'temperature' symbol from the settings menu.

The temperature screen is displayed if two or more cavity temperatures are set above the minimum. You can now:

- A) Change a temperature set
- B) Edit the existing temperature labels
- C) Add a new temperature
- D) Change the measurement unit

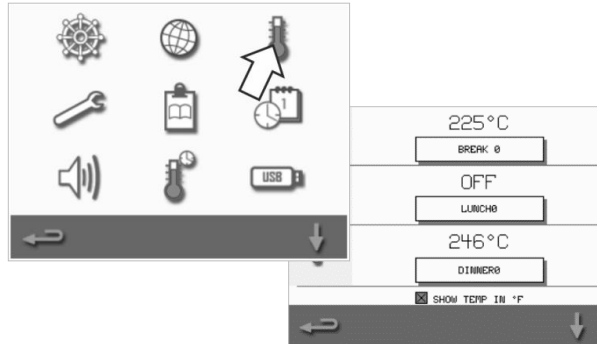

A) Change a temperature set

1. Select the temperature you want to change by tapping the value or the red temperature symbol next to it.
2. Edit the temperature as required using the keypad.
3. Select the tick to continue.

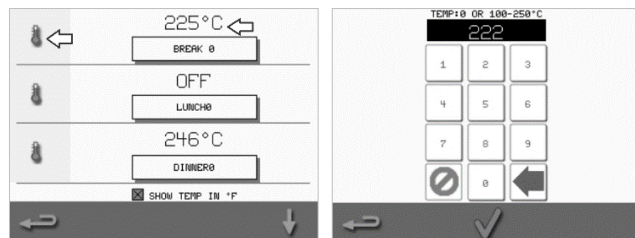

B) Edit temperature labels

1. Select the required label below the temperature.
2. Edit the label as required using the keypad
3. Select the tick to continue.

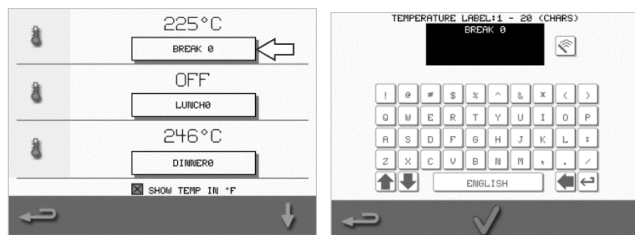

C) Add a new temperature

1. Select a disabled temperature option from the screen (scroll down using arrow if required).
2. Select the temperature area marked as 'disabled' or the red temperature symbol.
3. Enter a temperature value using the keypad and select the tick to continue.
4. Select the 'Optional Label' box to assign a label to the temperature and select the tick to continue.

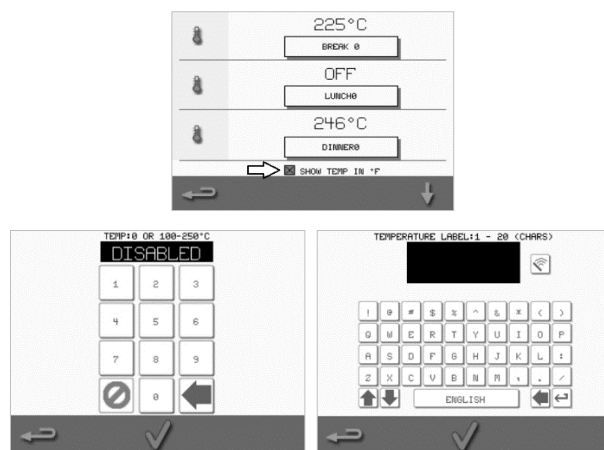

D) Change measurement unit

You can change the temperature measurement unit from Celsius to Fahrenheit and Fahrenheit to Celsius by simply selecting or deselecting the unit checkbox.

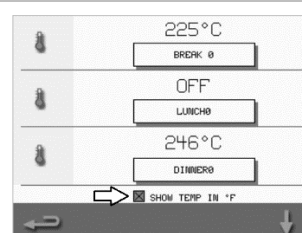

Service information and error logs

The service information and error log function is required for servicing and repairing the system and therefore covered in the *Service and Repair Guide*.

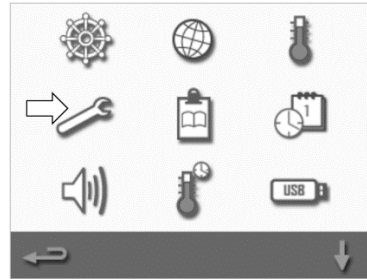

Cooking profile counters

1. Select the 'clipboard' symbol to display a listing of cooking profile counters.

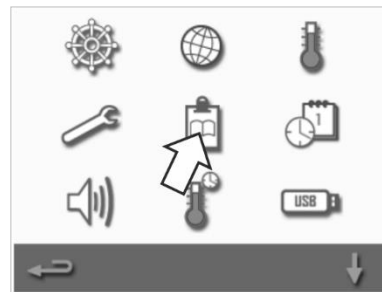

2. The recipe counts are listed on the right of the screen. Use the up/down arrows at the bottom of the screen to scroll to the required recipe.

| RECIPE COUNTERS | |
|-----------------|---|
| TEST | 0 |
| APPLE STRUDEL | 0 |
| BAKED GOODS | 0 |
| BAGUETTE LONG | 0 |
| BAGUETTE BUN | 0 |
| SUPPLE- MENTS | 0 |

Adding recipes

Recipes can be uploaded from a USB stick. See *USB programme downloads*.

Removing recipes

You can remove a recipe by selecting it and then selecting the bin symbol.



Setting the date and time

1. Select the 'clock/date' symbol from the settings menu to display the setting options.

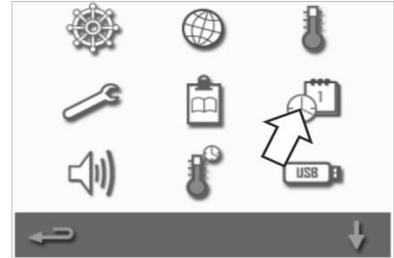

Change the date:

2. Select 'MONTH', enter the correct month on the keypad and select OK.
3. Select 'DAY', enter the correct day on the keypad and select OK.
4. Select 'YEAR', enter the correct last two digits of the year on the keypad and select OK.
To display the month first, followed by the day and year, select the 'MM-DD-YY' checkbox.
A correct date supports servicing as the error logs are recorded using these date settings.

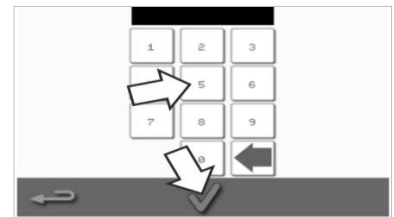
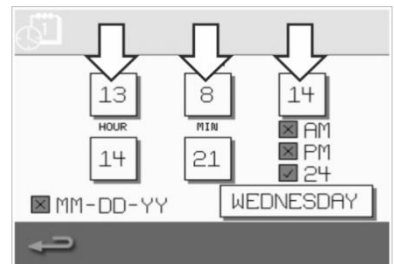

Change the time:

5. Select 'HOUR', enter the correct hour on the keypad and select OK.
6. Select 'MIN', enter the correct minutes on the keypad and select OK.

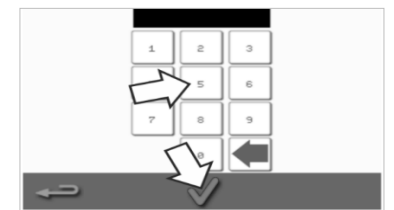
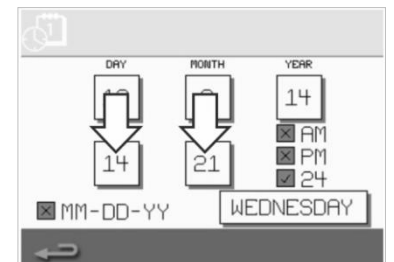

7. Select the day name.

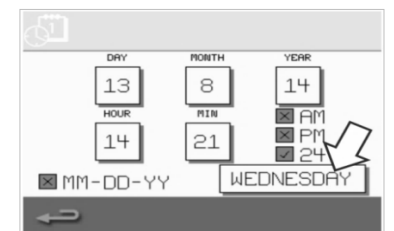

Sound settings

1. Select the 'speaker' symbol to access the volume, tone and further sound settings.

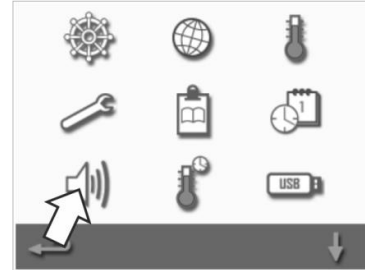

2. Make changes as required:

- a) Select the 'speaker' symbol to adjust the volume level suitable for the environment from none (OFF) to the loudest (100%).
- b) Select the 'music note' symbol to set LOW, MED or HIGH tone.
- c) Select the 'keypad' symbol to switch the sound ON or OFF when the touchscreen is pressed.

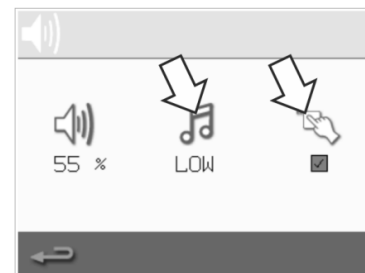

Temperature timer setting

1. Select the 'thermometer / timer' symbol from the settings menu.

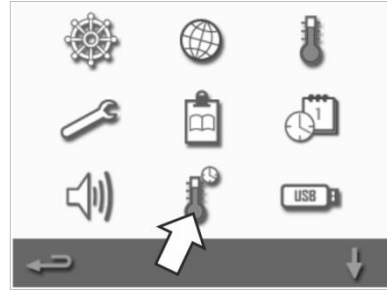

2. Select the 'timer enabled' checkbox (green tick).
3. Select a weekday using the up/down arrows at the bottom of the screen.
4. Select an empty 'time' box (maximum of five per day) or clear an existing 'time' box using the 'wipe' symbol next to it.

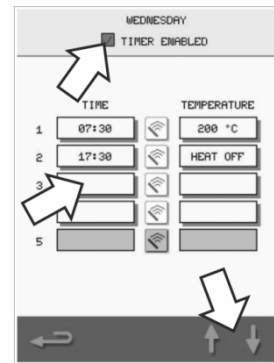

5. Enter the start time on the keypad.
Press the green tick to continue.

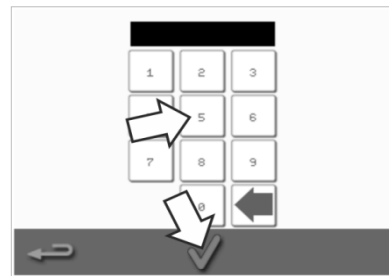

6. Select an empty 'temperature' box opposite the respective 'time' box or clear the required 'temperature' box using the 'wipe' symbol next to it.

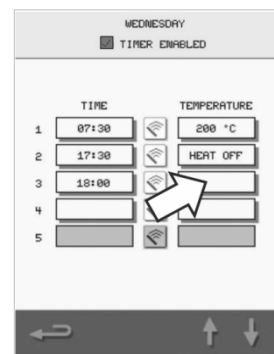

7. Enter the cavity temperature required on the keypad.

Alternatively:

- Select zero to turn the heat OFF.
- Select the red circle symbol to switch OFF the appliance.

Press the green tick to continue.

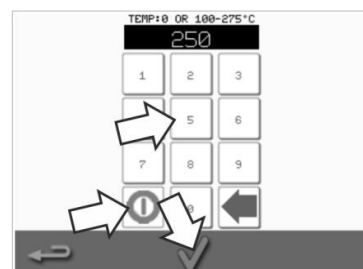

USB programme downloads

1. Switch the appliance OFF and open the cover to the USB port on the control panel.

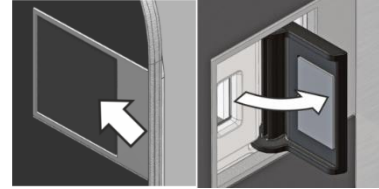

2. Plug in the USB memory stick and switch on the oven.

Note: If the USB memory stick is too large, use a standard commercial adapter cable.

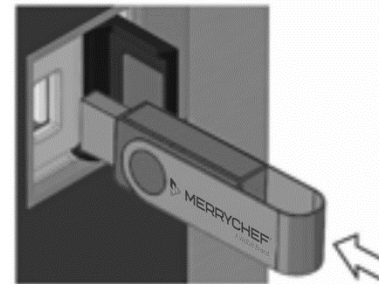

3. Select the 'USB' symbol from the settings menu.

Note: Check that the memory stick has the correct number/code for the programmes you want to load into the memory (one '.cbr' file and 'autoupdate').



4. Select the type of file you are downloading (firmware or recipes). The files will now automatically download from the USB memory stick showing the progress and confirmation screens for the update.



IMPORTANT: Downloading from a USB memory stick will clear all the existing programmes in the memory of the appliance.



The USB cover protects the USB port so that no water vapour can get into the control electronics. During cooking and cleaning, there must not be a USB memory stick inserted and the USB port must be closed by the cover.



Temperature band setting

1. Select the 'temperature band' symbol.



2. Select the required temperature band checkbox, shown by a green tick.

Note: Generally, the lowest practical 'Temp Band' should be chosen. If the set cavity temperature falls by more than the selected temperature band value, the ready-to-cook mode and the temperature band are deactivated until the cavity reaches the preset preheat temperature.

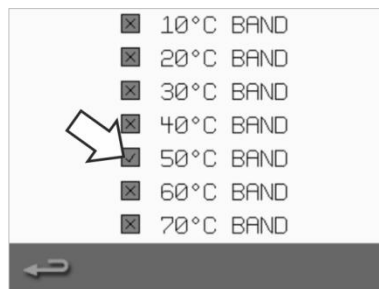

Change setting / service access password

1. Select the 'key' symbol to change the passwords of the appliance.



2. Select the appliance 'settings' or 'service' symbol.

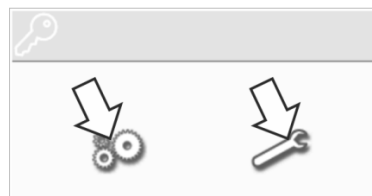

3. Enter the existing password and press the green tick to confirm.

4. Enter a new password and press the green tick.

5. Confirm the new password and press the green tick again.

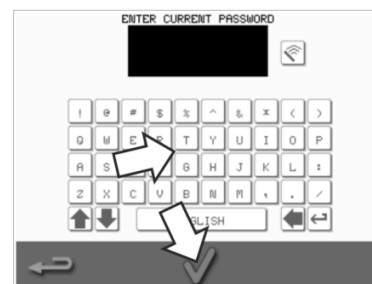

Set screen saver

1. Select the 'ENABLED' checkbox to switch the screen saver ON or OFF and select the 'time' box below it.



2. Enter a time delay on the keypad from 1 to 60 minutes before the screen saver starts. Press the green tick to confirm.

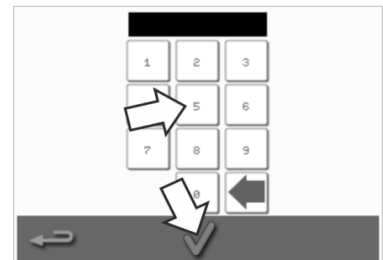

3. An active screen saver will mask the screen showing a moving image. To use the touchscreen, tap the screen to deactivate the screen saver.



2G. Cool-down procedures



The microwave combination oven must be cooled down properly before cleaning, servicing or repairing. Users must read *Section 1H: Hazards and safety precautions during servicing and repair* and *Section 1I: Hazards and safety precautions when taking the appliance out of service*.

To cool down the appliance:

1. Select the thermometer symbol from the cookbook or the cleaning symbol from the main menu (full serve mode).

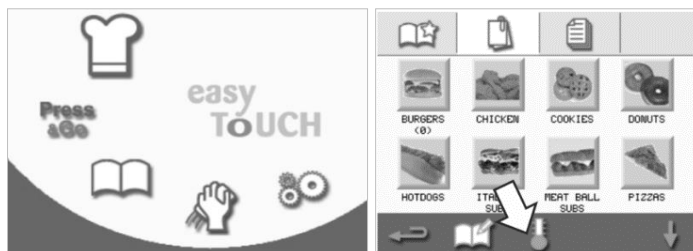

2. In the temperature screen, select the blue thermometer symbol to disable heating and start the cooling cycle.



3. The cooling progress is displayed and takes approximately 20 minutes. To reduce the cool-down time, leave the appliance door open slightly during the cooling process.

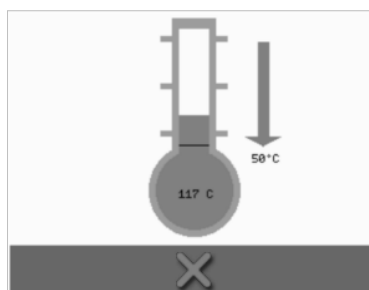

4. Once the cooling process is complete, you will see a 'Clean Cavity' screen. The oven is now ready for cleaning or servicing and repairing.

Cleaning instructions is provided in *Section 2H: Cleaning procedures*.

Servicing and repairing is covered in the *Service and Repair Guide*.



2H. Cleaning procedures

Daily cleaning tasks

| What must be cleaned? | Procedure | Cleaning chemicals |
|--|--|--|
| Cavity | Clean by hand with a soft cloth or paper towel | Cleaning and protective chemicals approved by the manufacturer |
| Outside of appliance | Clean by hand with a soft cloth | Common household stainless-steel cleaner or hard surface cleaner |
| Containers, baking sheets, shelf grills and other accessories used for cooking | Clean by hand with a soft non-abrasive sponge and rinse off after with water | Common household detergent |
| Air filter | Wipe clean or wash in soapy water | Common household detergent |

Table 2.5: Cleaning tasks

Cleaning items

Use solely the cleaning chemicals specified in Table 2.6 to clean the microwave combination oven and its accessories.







| Product | | Use |
|---|---|---|
| Merrychef Cleaner |  | Cleaning the cavity and appliance door |
| Merrychef Protector | | Protecting the cavity and appliance door |
| Common household stainless-steel cleaner or hard surface cleaner |  | Caring for the external surfaces of the microwave combination oven |
| Common household detergent: mild on skin, alkali-free, pH-neutral and odourless | | Cleaning components and accessories and fittings according to relevant instructions |
| Protective rubber gloves |  | To protect hands from cleaning agents |
| Non-abrasive nylon scrub pad |  | For all surface and door cleaning |
| Cleaning towel and cloths |  | For all surface and door cleaning |
| Eye protection |  | To protect eyes from cleaning agents |
| Dust mask (optional) |  | To protect from inhaling cleaning agents |

Table 2.6: Cleaning items



Cleaning instructions



- Ensure the oven has been cooled down as per the instructions in *Section 2G: Cool-down procedures*.
- Users must read *Section 1G: Hazards and safety precautions during cleaning*.
- Wear protective glasses and protective rubber gloves during cleaning.

CAUTION

- Never use sharp implements or harsh abrasives on any part of the appliance.
- Do not use caustic cleaners on any part of the appliance or cavity.
- Do not scrub the roof (jet plate) or door seal.
- Do not use metallic scourers on any part of the appliance at any time.
- Do not spray cleaning product directly into the cavity.
- Do not use the appliance without a clean air filter in place.

Pre-cleaning checklist

- The appliance has been cooled down correctly
- No food has been left in the cavity.
- All containers, baking sheets, shelf grills and any other accessories have been removed from the cavity.

Cleaning process

There are several stages in the cleaning process:

Stage 1: Clean and dry the oven and oven parts

Stage 2: Apply oven protector (optional)

Stage 3: Clean the air filter and external surfaces

Stage 4: Cure the protective chemical (if oven protector applied)



Stage 1: Clean and dry the oven and oven parts

1. In a cooled-down oven (see section 2G), open the door and remove the cook plate and any other cooking accessories.

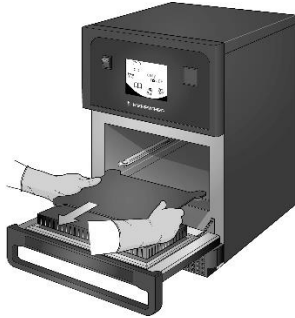

2. Wash all removed oven parts in warm soapy water. Wash off using a clean cloth and plenty of warm water.

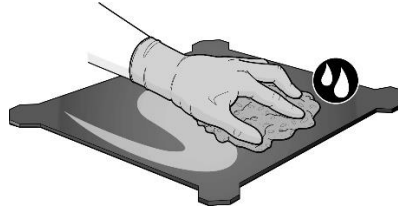

3. Use a dry clean brush to remove any food particles from between the cavity floor and the inside of the front door.

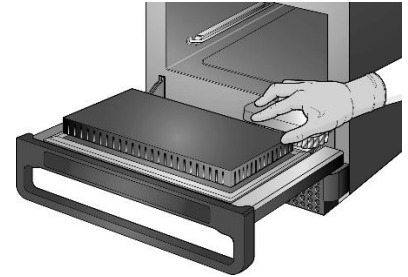

4. Spray Merrychef approved cleaner onto a sponge and clean all internal surfaces **except the cavity roof (jet plate) and door seal**.

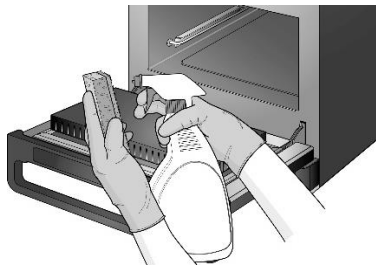

Do not spray directly into the cavity.

5. For difficult areas, leave to soak for 10 minutes with the appliance door open. Use a non-abrasive nylon scrub.

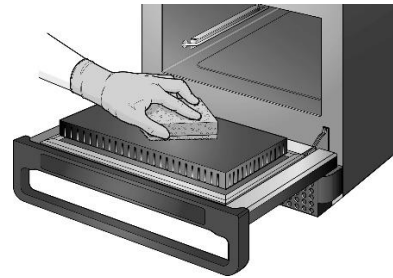

Do not scrub.

6. Wash off all surfaces using a wet clean cloth. The cavity roof and door seal can be wiped clean with a wet clean cloth as well.

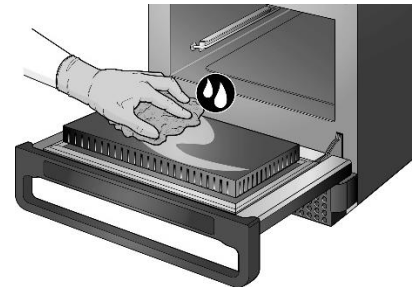

7. Dry all surfaces and oven parts using a clean cloth or paper towel.

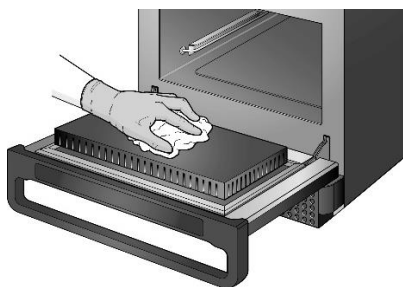

8. Press the tick on the clean cavity screen to continue.



9. A prompt will appear to apply the oven protector (optional).

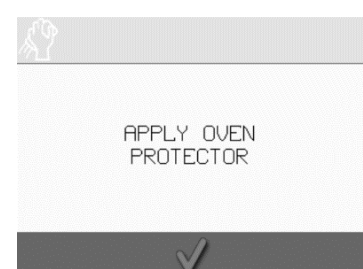

Stage 2: Apply oven protector (optional)

1. Spray Merrychef protector or a Merrychef approved protector onto a clean sponge.



2. Spread the protective chemical lightly onto all internal surfaces, avoiding the roof (jet plate) and door seal.

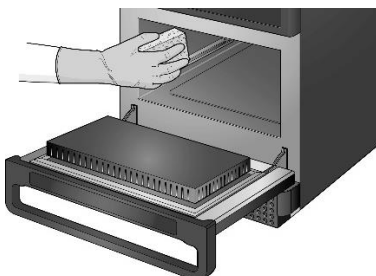

3. Replace the cleaned and dried cook plate.

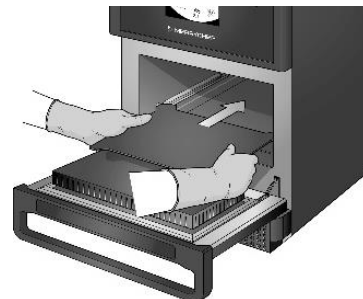

4. Press the tick on the apply oven protector screen to continue.



5. A prompt appears to clean the air filter.



Stage 3: Clean the air filter and external surfaces

1. Remove the air filter by gently pulling it.

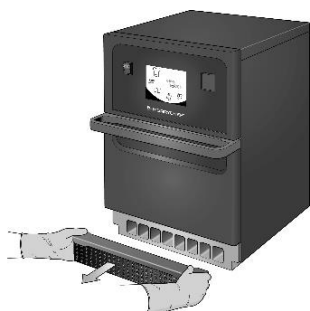

2. Wipe the air filter clean or wash in soapy water.

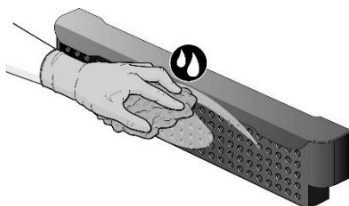

3. Dry and replace the air filter.

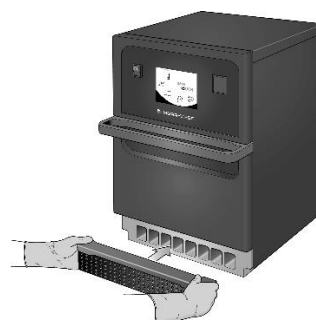

4. Press the green tick to confirm cleaning of the air filter.

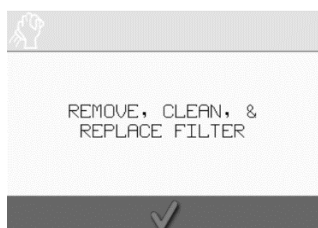

5. The oven switches OFF automatically.

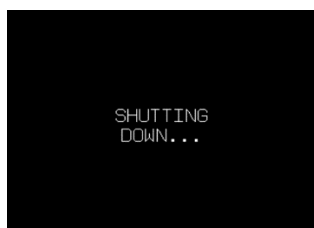

6. Wipe the external surfaces of the oven with a damp cloth.



Stage 4: Cure protective chemical (if oven protector applied)

1. Switch ON the appliance using the on/off button.



2. Preheat the cavity. Once reaching the preset operating temperature it will take about 30 minutes to cure the protective chemical.

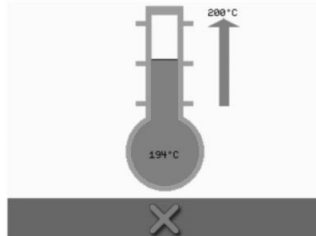

3. The protective chemical turns light brown when cured and the oven is ready to be used again.



2I. End of day operations

Turning the oven off

- 1.



Switch off the microwave combination oven using the on/off switch at the front of the appliance.

- 2.



Leave the appliance door ajar to let moisture escape.

Note: Switch off the power on site, before prolonged breaks in use.



2J. Servicing information

Warranty information and contacting customer services

In order to be able to claim under the warranty for the microwave combination oven, the appliance must be installed in accordance with the instructions in the *Operations and Installation Guide* by a qualified service engineer from an authorised service company.

The warranty does not cover damage resulting from improper setup, installation, use, cleaning, use of cleaning chemicals, servicing or repair.

Required information

Please have the following appliance data to hand when contacting Welbilt customer service:

- Serial number of your appliance
- Part number if you are calling about a specific part of the appliance

This serial number of the appliance can be found at the rear of the oven on the nameplate, as shown in Figure 2.5.



Figure 2.5: e1s rear view with nameplate

Contact data

Welbilt UK Ltd.
Ashbourne House, The Guildway,
Old Portsmouth Road
Guildford, GU3 1LR
United Kingdom
Tel: +44 (0) 1483 464900
Fax: +44 (0) 1483 464905
Website: www.merrychef.com and www.welbilt.com



For further information on servicing, maintenance and repair, please refer to the *Service and Repair Guide*.



Fault finding

Although every effort is made to ensure your oven will continue to perform to a high standard, please check Table 2.7 to see if the problem can be easily resolved before contacting your service agent.

| Problem | Possible cause | Remedy |
|---|---|--|
| The appliance does not work and the display screen is blank | <ul style="list-style-type: none"> The appliance has no power | <ul style="list-style-type: none"> Check if there is a power cut Check if the isolator switch is ON or the appliance is plugged in correctly Check if the appliance switch is ON |
| Some screen controls do not work | <ul style="list-style-type: none"> Unauthorised access | <ul style="list-style-type: none"> Contact an authorised user |
| Display shows a warning message | <ul style="list-style-type: none"> Details are shown on screen | <ul style="list-style-type: none"> Follow the instructions displayed |
| The appliance does not cook the food correctly | <ul style="list-style-type: none"> Appliance is not clean Food not at correct temperature Modified or wrong programme selected Food wrapped Food removed early | <ul style="list-style-type: none"> Clean the appliance Use the correct cooking programme Unwrap food Check if all the cooking stages have been followed correctly |
| The appliance does not finish cooking | <ul style="list-style-type: none"> Warning message displayed The appliance door is open No air filter or incorrectly fitted Overheating of the appliance | <ul style="list-style-type: none"> Close the appliance door Refit the air filter Allow the appliance to cool down Check and remove any restrictions around the air vents |
| Display shows an error code | <ul style="list-style-type: none"> Malfunction of the appliance | <ul style="list-style-type: none"> Note the error code and contact your service agent |

Table 2.7: Fault finding guidelines



For further information on servicing, maintenance and repair, please refer to the *Service and Repair Guide*.



eikon[®] e1s

Microwave Combination Oven



Welbilt is one of the world's largest manufacturers and suppliers of professional gastronomic appliances. We supply our customers with energy-saving, reliable and market-leading technologies from a single source. If you want to find out more about Welbilt and its company brands, please visit us at www.welbilt.com